

# PHOENIX

## GRILLS

# Owner's Manual

## Assembly and Maintenance Instructions

**THIS GAS APPLIANCE IS DESIGNED FOR OUTDOOR USE ONLY.**



**GAS-FIRED**



**MH49347**

**LISTED**

**Model: SDRIVDD - SDRIV4LDD**

**THESE INSTRUCTIONS SHOULD BE LEFT WITH THE CUSTOMER. KEEP THESE INSTRUCTIONS FOR FUTURE REFERENCE.**

**YOU MUST READ THIS OWNERS MANUAL BEFORE OPERATING YOUR GAS GRILL.**

**THE STAINLESS STEEL WILL TURN A MILD GOLD PATINA FROM THE GRILL'S HEAT. THIS IS NORMAL.**

### **⚠ FOR YOUR SAFETY**

**If you smell gas:**

- 1. Shut off gas to appliance.**
- 2. Extinguish any open flame.**
- 3. Open Lid.**
- 4. If odor continues, immediately call your gas supplier or your fire department.**

### **⚠ FOR YOUR SAFETY**

- 1. Do not store or use gasoline or other flammable vapors and liquids in the vicinity of this or any other appliance.**
- 2. An LP cylinder not connected for use shall not be stored in the vicinity of this or any other appliance.**

### **⚠ FOR YOUR SAFETY**

**Follow all leak-test procedures carefully in this manual before using. Do this even if the grill was dealer assembled. Do not try to light this appliance without reading the "Lighting" instructions in this manual.**

# PHOENIX GRILLS

## **Note To Customer:**

We recommend that you “break in” your grill by cooking the first two or three times at medium or low temperature settings. This allows the cast aluminum drip pan to “season/break in”.

**Caution:** We recommend after each use, you turn the control knobs to **HIGH** (with the lid closed) and run the grill for approximately 10 minutes. This will allow the accumulated fats and greases to cook off, and avoid a possible flare up on the next use. **HINT:** The fats and greases are cooked off when no more smoke is flowing from the grill vents.

## **Safety**

**READ** this book first!  
**SAVE** this manual for future reference!

Your new gas grill is a safe, convenient appliance when assembled and used properly. However, as with all gas-fired products, certain safeguards must be observed. **Failure to follow these safeguards may result in hazardous fire or an explosion causing serious bodily injury or property damage.** If you have any questions concerning the assembly or operation of this appliance after reading these instructions thoroughly, consult your dealer, gas appliance serviceman, or your propane gas company.

 **CALIFORNIA PROPOSITION 65 WARNING:** Chemicals known to the State of California to cause cancer, and birth defects or other reproductive harm are created by the combustion of propane, charcoal, wood products, or natural gas used with this grill, and in the preparation of grilled foods.

 **The SAFETY symbol identifies the most important safety messages in this manual. When you see the SAFETY symbol, Be Alert to the possibility of personal injury and carefully read the messages that follow.**

**Installer:** These instructions **MUST** be left with the consumer.

**Consumer:** Retain these instructions for future use.

## **SAFETY**

### **For Your Safety**

Never check for gas leaks with a lighted match or open flame.

- This grill is for outdoor use only.
- Never leave a lit grill unattended.**
- Do not let children operate or play near your grill.
- This grill is for use with propane gas only.
- Always leave filled cylinders outdoors.

### **Plan The Location Carefully**

This grill is for outdoor use only. The grill is not to be used in a building, garage or any other enclosed area. Installation of this appliance must be in accordance with all applicable local codes and gas utility requirements. In the absence of local codes, installation must be in accordance with current National Fuel Gas Code, Z223, I/NFPA54 (Latest Edition) or CAN/CGA-B149.1, Natural Gas Installation Code or Can/CGA-B149.2 Propane Installation Code.

**This appliance is for outdoor installation only in a well ventilated space. This grill is not intended to be installed in or on any recreational vehicle and/or boats.**

## SAFETY

### IMPORTANT!

Check for compliance to these safety rules before each use!

- Maintain a minimum clearance of 24 inches (61 cm) from sides and back of the grill to any combustible construction.
- Do not use this appliance under overhead combustible surfaces.
- Always keep the area around the grill clear from any combustible materials, gasoline, and other flammable gas and liquids.
- Do not block air to the appliance.
- Do not block ventilation openings.

### LP Gas Cylinder

The LP Gas Cylinder which you purchase separately for use with this grill must meet the following requirements and be equipped with a listed **Overfilling Protection Device**.

All LP gas cylinders used with this appliance must be approximately 12" (30.5 cm) in diameter and approximately 18" (45.7 cm) in height. The maximum fuel capacity shall be 20 lbs. (9.1 kg) of Propane (43.7 lbs. normal water capacity). The propane tank must be provided with a shut-off valve terminating in a propane gas tank valve outlet and be provided with an overfilling protection device.

**Please Note: Your Propane Tank accepts a Type I, also known a "Quick Connect Valve"**

## SAFETY

### OPD—Overfilling Protection Device

As stated, the cylinder you purchase must be equipped with an overfilling protection device. This type of cylinder can be identified by its triangular shaped tank valve and handle (see page 9 for diagram of tank valve and handle).

**Be Certain** if you exchange your cylinder, that the cylinder you receive in exchange has this new **OPD** safety device.

The cylinder must be arranged for vapor withdrawal and remain in the upright position. The cylinders must include a collar to protect the cylinder valve.

All LP gas cylinders used with this appliance must be marked in accordance with the specifications for LP gas cylinders of the US Depart-

ment of Transportation (DOT), or the National Standard of Canada CAN/CSA-B339 Cylinder, Spheres and Tubes For Transportation of Dangerous Goods, and Commission as Applicable.

### Use of LP Cylinder

**Refer to the assembly instructions section and the label on the LP cylinder for guidance on proper installation and disconnection of the LP cylinder.**

## SAFETY

### Use of Cylinder Dust Cap

The cylinder dust cap provided with your tank must be used whenever the cylinder tank is not connected to the grill gas system. Install the dust cap onto the tank valve. Always use the tank dust cap and be sure the tank valve is closed when storing or transporting the tank.

#### NOTE:

- The tank valve must be closed even when using the dust cap.
- Always transport, store and use the tank in an upright position.
- DO NOT take or store the tank in a building, garage or enclosed area.
- Always keep the tank valve closed when the grill is not in use.
- When removing the dust cap, do so slowly and only after checking to ensure that the tank valve is still closed.
- Read and follow all safety rules in your instruction books and on cylinder tank.

## SAFETY

### Filling the LP Cylinder

Have the tank filled by a reputable propane gas dealer. The air must be purged from the tank by your propane gas dealer before the first filling. Have your propane gas dealer check the relief valve after filling to ensure that it remains free to function, and check for leaks.

## SAFETY Storage

DO NOT store the LP cylinder in direct sunlight. When the grill is to be stored indoors, the propane tank **MUST** be disconnected. The propane tank must be stored outdoors in a

well ventilated space, NOT in a building, garage, or any other enclosed area. It must be out of reach of children. A dust cap **MUST** be used whenever the tank is disconnected from the grill. When grill is not in use, close propane tank cylinder valve.

When the propane tank is connected, the grill must be stored outdoors in a well ventilated space, not in a building, garage or any other enclosed area. Always close the propane tank before disconnecting it from the grill or when the grill is not in use.

If the grill is going to be stored for winter or for an extended period of time, we suggest you follow these steps:

- The burner should be cleaned and coated lightly with cooking oil to prevent from rusting.
- The venturi openings should be covered with aluminum foil to prevent small insects from entering the opening during storage and must be removed before using.
- The grill should be covered if it is left outdoors. Grill covers are available as an accessory.
- Follow the cleaning procedures.

### Hose and Regulator

The pressure regulator and hose assembly supplied with the appliance must be used. This pressure regulator is preset for an outlet pressure of 11 inches (27.9 cm) water column. Therefore, this pressure regulator **MUST** be used with your Phoenix Grill. Before each use of the grill inspect the hose for wear, cracking and examine for any cuts. If any these conditions exist, **do not use**, purchase a new hose and regulator. If a replacement is needed, refer to the parts list for the part number and contact the dealer where your grill was purchased. Refer to **“Connecting the Cylinder to the Grill”** for details of hooking up your regulator to the LP gas cylinder. Make sure a leak test is performed every time you have your LP gas cylinder refilled, and visibly inspect for excessive wear and damage on a regular basis. Always follow the directions for the “Leak Test”.

### Natural Gas

Your grill may be converted to natural gas by replacing the LP Valve with the appropriate Natural Gas Valve. (Part #HHVLV32-SD). A conversion should only be made by an authorized

Phoenix Grill dealer or local gas utility in accordance with all applicable codes. **CAUTION:** Any additions, changes, or conversions required in order for the appliance to satisfactorily meet the application needs must be made by a Phoenix dealer or local gas utility using factory specified and approved parts. Always remember to shut gas off at gas connection when grill is not in use.

### SAFETY

#### Leak Test

Check for leaks before lighting the grill for the first time, after storing the grill between seasons and after refilling the propane cylinder.

**Take your grill outdoors into a well ventilated area. Do not use or permit sources of ignition in the area during this test, this includes smoking. Use only a soap and water solution to test for leaks.**

#### Leak Test Check List

- Tank valve (all over) including area that screws into the tank and the welds.
- Regulator fitting
- Hose connections
- Valves

#### Mandatory Leak Test

1. Have propane tank filled with propane gas only by a reputable propane gas dealer.
2. Attach regulator fitting to tank valve.
3. Tighten regulator fitting securely.
4. Turn the control knobs to the right, clockwise. This is the **“OFF”** position.
5. Make a solution of half liquid detergent and half water.
6. Turn gas supply **“ON”** at the tank valve (counter clockwise).
7. Brush soapy mixture on all connections listed in the **Leak Test Check List**.
8. Observe each place for bubbles caused by leaks.
9. Tighten any leaking connections, if possible. If leak cannot be stopped, **DO NOT USE THE GRILL**. Order new parts from an authorized Phoenix dealer. Do not use the grill until after the new parts are installed. After installing new parts, perform complete leak test.
10. Turn gas supply **“OFF”** at the tank valve.

# Phoenix Grill WARRANTY

## **10-YEAR WARRANTY ON THE FOLLOWING:**

*(Against Rust Through)*

- Riveted Stainless Steel Grill Top & Bottom • Stainless Steel Control Panel • Stainless Steel Column & Base • Stainless Steel Burner • Stainless Steel Cooking Grid • Stainless Steel Side Shelves • Cast Aluminum Drip Pan

## **1-YEAR WARRANTY ON THE FOLLOWING:**

*(Against Rust Through)*

- All other Components including; • Igniter System • Gas Valves • Knobs • Drain Valve  
• Temperature Gauge • Grease Bucket • Hose & Regulator  
• Wheels • Hood Handle

### **WHAT IS NOT COVERED:**

Surface Corrosion and Discoloration • Transportation and shipping cost • Labor for replacement or repairs • Damage from accident, misuse, alteration, abuse, improper installation or storage • Removal and reinstallation costs • Finishes on surface that are damaged by improper installation, improper storage, accident, misuse, abuse or alteration • Inoperable due to improper installation or storage • The costs of a service call to diagnose a problem • All warranties are non-transferable and apply only to the original purchaser • Warranties are null and void if grills are put into commercial or community use. This warranty does not imply or assume any responsibility for consequential damages that might result from use, misuse, or improper installation of this cooking appliance. This warranty does not cover claims, which do not involve defective workmanship or materials, bill of sale, cancelled check, or payment record should be kept to verify purchase date and establish warranty period.

*Grills in a commercial, community or multi tenant applications will have a 1 year warranty on all parts.*

### **MODEL IDENTIFICATION**

Your Phoenix Grill is identified by a model number and a serial number located on the left side of the control panel. Always use both the model and serial numbers when contacting ProFire Grills about your grill. For future reference, take the time now to record the model and serial numbers below:

**MODEL NUMBER:** \_\_\_\_\_ **SERIAL NUMBER:** \_\_\_\_\_ **DATE PURCHASED:** \_\_\_\_\_

**How to contact us:** phone: 1-888-781-4657, fax: 1-800-781-3965, E-mail: [info@profiregrills.com](mailto:info@profiregrills.com) or write: Customer Service, ProFire Grills 5565 North 124th Street, Butler, WI 53007.

# GETTING TO KNOW YOUR PHOENIX GAS GRILL

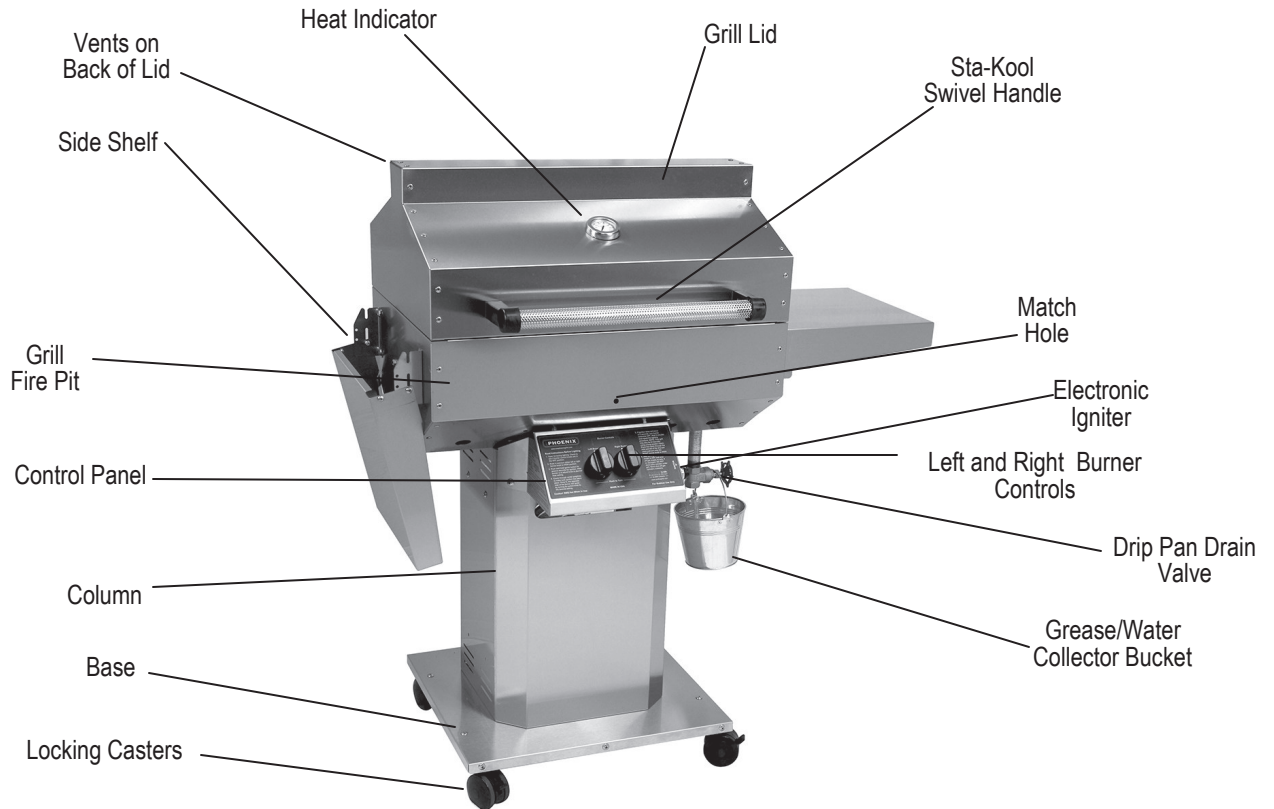

## Vents On Rear Of Lid



## INSIDE VIEW

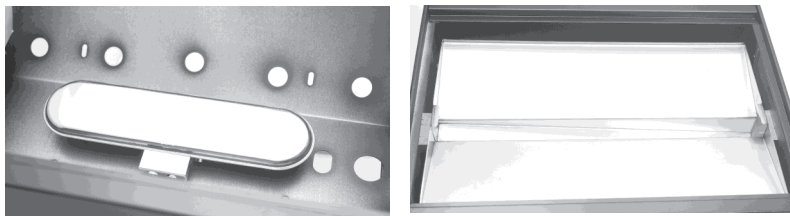

Dual Burner and Gas Collector Box

Cast Aluminum Drip Pan

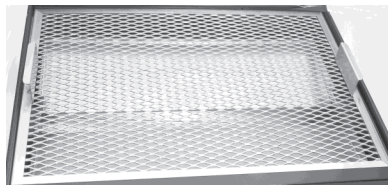

Stainless Steel Cooking Grid

## Back View of Column

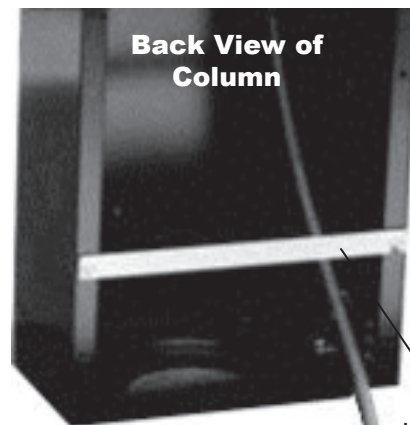

Tank Locking Bar On Propane Model

12 Ft. Hose with Quick Disconnect Included with Natural Gas Model

# Phoenix Grill Assembly Instructions

## Carton contains the following components for assembly:

Please check to be sure that all parts are included before proceeding. Contact your dealer or the factory if any parts are missing.

### Grill and Cart Components

Grill Lid	1
Grill Bottom with Pre-Assembled Burner, Gas Collector Box and Igniter Wire	1
Hinge Pins and Clips	2 Each
Column	3 (Front, 2 Sides)
Tank Locking Bar (See Pre-Pack Below) <b><u>(Propane Model)</u></b>	1 Pre-Pack
12 Ft. Hose with Quick Disconnect <b><u>(Natural Gas Model)</u></b>	1
Base	1
Locking Casters	4
Control Panel with Pre-Assembled Valve, Hose, Regulator and Igniter	1
Burner Control Knobs	2
Electronic Igniter	1
Temperature Gauge	1
Shelf Brackets, Shelves (See Pre-Pack Below)	1 Pre-Pack
Stainless Steel Handle, Handle End Caps (See Pre-Pack Below)	1 Pre-Pack
Cast Aluminum Drip Pan	1
Stainless Steel Cooking Grid	1
Drip Pan Drain Valve	1
Collector Bucket	1
Heat Indicator	1

#### Pre-Packaged Part and Fasteners

**Tank Locking Bar**- Nylon Spacer, 1/4" x 1" Hex Bolt (2), 1/4" Flat Washers (4) and 1/4-20 Kep Nuts (2).

**Handle**- Handle End Caps (2), Graphite Gasket (2), 1/4 x 1" Hex Bolts (2), and Kep Nuts 1/4-20 (2)

**Shelf Assembly**- Shelf Brackets (4), Shelves (2), Hex Head Bolts (8), #10 Lock Washer (8), 10/24" x 1/2" Phillips Head (8), Nylon Lock Nuts 10-24 (8), and Kep Nuts 1/4-20 (8)

### Hardware/Fasteners

HARDWARE	QUAN.	USE
1/4-20 x 1/2" Hex Head Bolt	12	Column to Base
KEP Nut 1/4-20	12	Column to Base
1/4-20 x 1/2" Hex Head Bolt	8	Heat Shield to Column
KEP Nut 1/4-20	8	Heat Shield to Column
1/4-20 x 1/2" Hex Head Bolt	6	Grill Bottom to Column
KEP Nut 1/4-20	6	Grill Bottom to Column
KEP Nut 1/4-20	2	2 Threaded Studs on Control Panel
1/4- 20 x 1/2" Hex Head Bolt	2	Control Panel to Column
KEP Nut 1/4-20	2	Control Panel To Column
Hinge Pin	2	Lid to Grill Bottom
Hinge Clip	2	Lid to Grill Bottom
1/4-20 x 1/2" Hex Head Bolt	16	Casters to Base

#### Fastener Totals

Hex Bolts 1/4-20x1/2	52
Kep Nuts 1/4-20	42
Hex Bolts 1/4-20x3/4	4
Phillips Head 10-24 x 1/2"	8
Nylon Lock Nut 10-24	8
Lock Washer #10	8

#### Tools Required For Assembly:

7/16" Wrench, 7/16" Socket Wrench with Extension, 3/8" Wrench.

**CAUTION:** Edges of some of the grill parts may be sharp, use care when assembling grill.

**CAUTION:** While handling the grill head be very careful not to damage the Venturi Tubes or the Ceramic Ignitor Insulator which protrudes from below the grill.

### TOOLS NEEDED FOR ASSEMBLY



Phillips and Straight Screw Driver



7/16 Wrench



7/16 Socket With Extension

## Step 1: Mounting Column to Base.

- Attach the front (center) section of the column to the base using (2) 1/4-20 x 1/2" hex head bolts and (2) 1/4-20 Kep nuts. **(Fig. A)**
- Attach the (2) sides of the column to the base using (4) 1/4-20 x 1/2" hex head bolts and (4) 1/4-20 Kep nuts. **(Fig. B)**
- Attach sides of column sections using (6) 1/4-20 x 1/2" hex head bolts and (6) 1/4-20 Kep nuts.
- Insert heat shield into top of column using (8) 1/4-20 x 1/2" hex head bolts and (8) 1/4-20 Kep nuts. **(Fig. D)**
- Lay base on its side and bolt casters into place with 1/4-20 x 1/2" Bolts at all (4) corners of base. **(Fig. E)**
- Attach the tank lock bar across the back of the column. Use the 3/4" Hex bolt, (4) 1/4" Flat Washers, Nylon Spacer and the 1/4-20 Kep nut on each side to fasten the bar in place. **(Fig. E-1)**



Fig. A

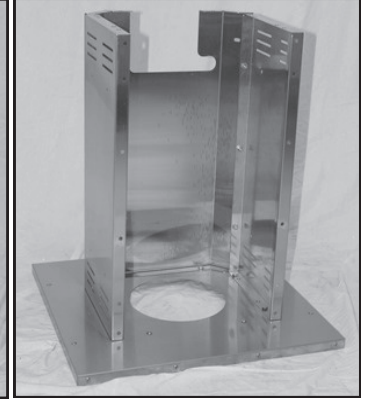

Fig. B

**NOTE: Finger tighten all bolts until the column is completely assembled on the base.**

Heat Shield

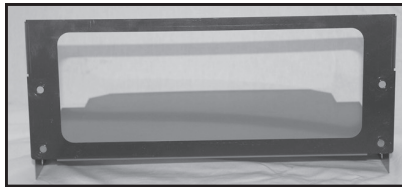

Fig. D

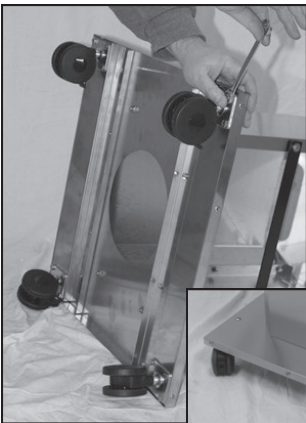
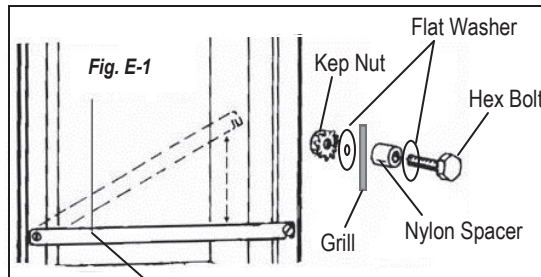

Fig. E



Tank Locking Bar  
Propane Model



Fig. F

## Step 2: Mounting Grill Fire Pit to Column.

- Set the grill pit onto the top of the column and align the (6) pit mounting holes to the matching holes in the column lip. Install the (6) 1/4-20 x 1/2" hex bolts and (6) 1/4-20 Kep nuts. Tighten securely. **(Fig. F)**

## Step 3: Attaching Control Panel to Grill Pit.

**NOTE:** The control panel has (2) threaded studs with a spacer nut that mounts to the fire pit allowing airflow between the pit and control panel. Also, the control panel comes with factory preassembled gas regulator, hose and igniter. **(Fig. G)**



Fig. G

Threaded Studs



## CONTINUE

### Step 3: Attaching Control Panel to Grill Pit.

- Attach the igniter probe wire (preassembled at factory to the gas collector box) to the electronic spark generator. **(Fig. I)**
- Attach the control panel to the front of pit by pushing the (2) threaded studs thru the holes in the bottom of the pit, making sure the venture tubes fit over the valve orifices and secure with (2) 1/4"-20 Kep nuts. **(Fig. J-1)**
- Attach the bottom of the control panel to column using (2) 1/4-20 x 1/2" hex head bolts and (2) 1/4-20 Kep nuts. Press the (2) gas control knobs onto the valve stems. **(Fig. J-2)**



Fig. H

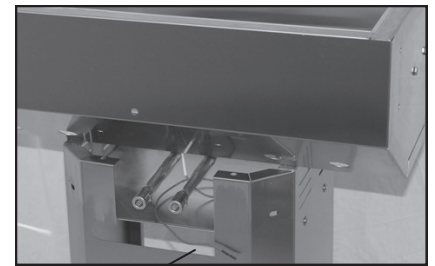

Igniter Wire

Fig. I



Fig. J-1



Fig. J-2

### Step 4: Attaching Side Shelves

- Remove white film from side shelves and grill.
- Attach brackets to grill using bolts and kep nuts to each side of your grill as shown in **(Fig. K-1)** Use 2 bolts and kep nuts per bracket.
- Place the left bottom shelf post into the left bottom bracket slot as shown in **(Fig. K-2)**. Gently spread the shelf apart to insert the right bottom shelf post into the right bottom bracket slot. Secure bottom posts with Nylock Nut—making sure nuts are snug but do not restrict the movement of folding and unfolding of the shelf.

**Note: Top posts on shelf do not use nuts.**

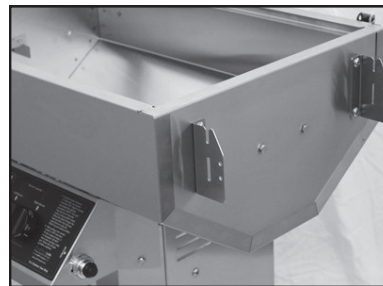

Fig. K-1



Fig. K-2

### Step 5: Lid Assembly to Fire Pit

- Position the top and bottom hinges together and complete assembly using the two (2) hinge pins and hinge clips. **(Fig. L)**
- With the lid open attach the handle to the lid using (2) 1/4-20 x 1" hex bolts, flat washers, graphite gaskets, and 1/4-20 Kep nuts. The gaskets are positioned between the handle end caps and grill lid. **(Fig. M)**
- Install the thermometer through the hole in the center of the lid. And snug thermometer with thumb bolt. **Do Not Over Tighten.** **(Fig. N)**

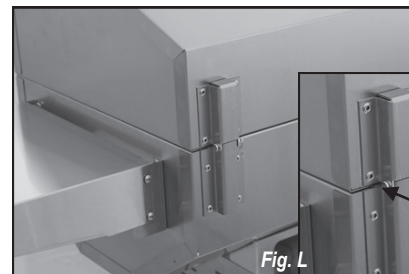
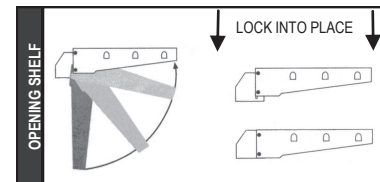

Fig. L



Hinge Clip

Hinge Pin

### Step 6: Install Drip Pan and Drain Valve

- With the lid open, insert drip pan into place using the lift tabs on each end. Line up the drain pipe with the hole in the pit bottom and make sure the drain pipe extends out the bottom of the pit. Install the brass valve onto the drain pipe, hand tighten only. **(Fig. O)** (You may need to remove the valve occasionally for cleaning. Hang the drain bucket on the brass valve and open valve. **(Fig. P)**)

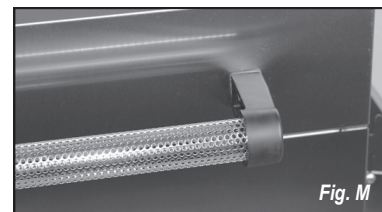
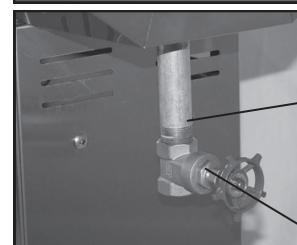

Fig. M



Fig. N



Drain Pipe

Brass Valve

Fig. O

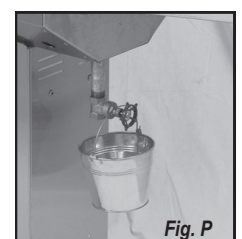
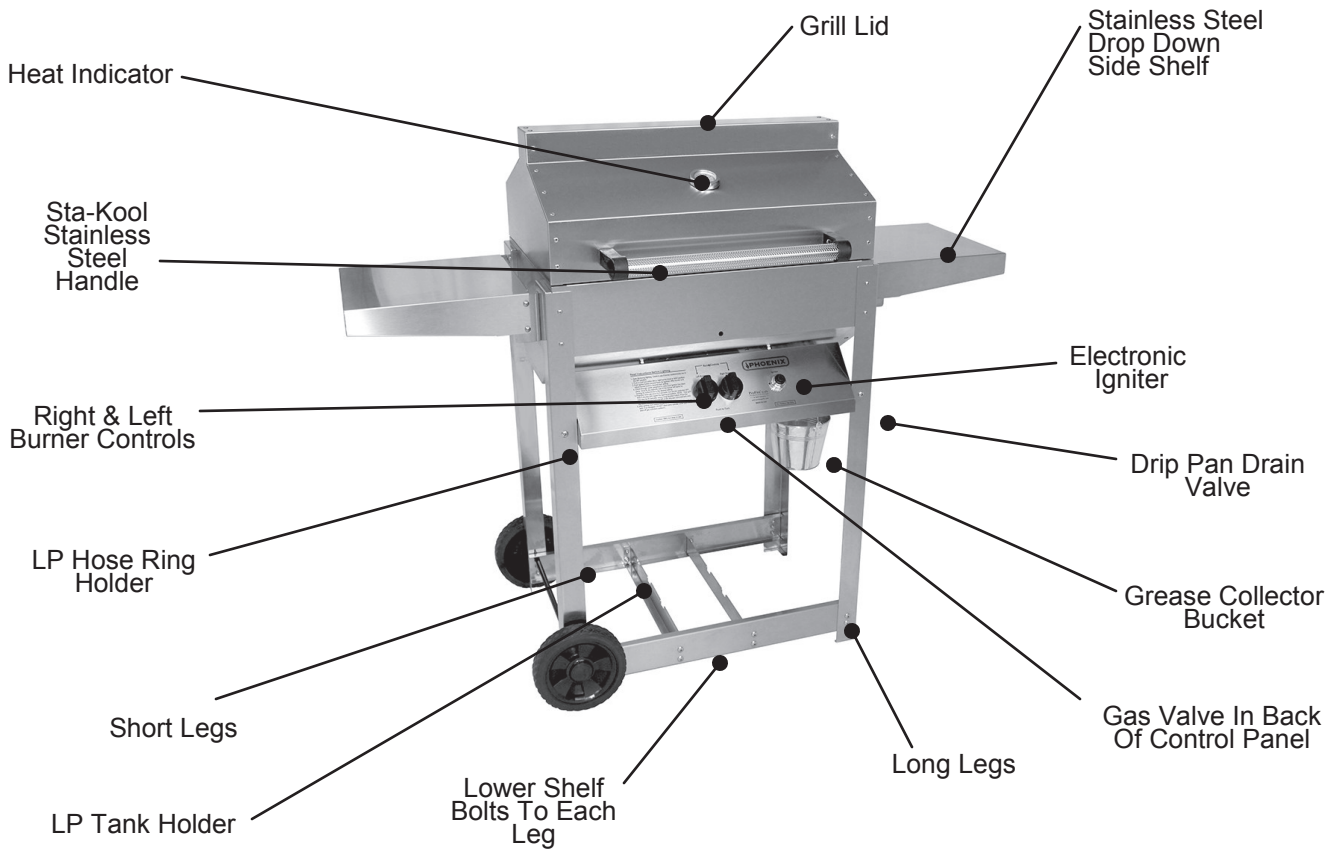

Fig. P

### Step 7: Install Cooking Grid

- Place the cooking grid into the grill.

# GETTING TO KNOW YOUR *SDRIV4LDD* PHOENIX GAS GRILL



## INSIDE VIEW

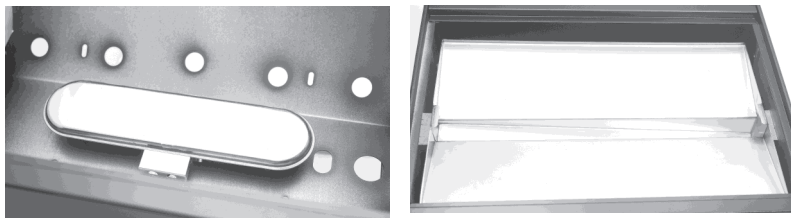

Dual Burner and Gas Collector Box

Drip Pan

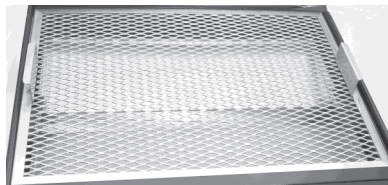

Cooking Grid

## REAR VIEW

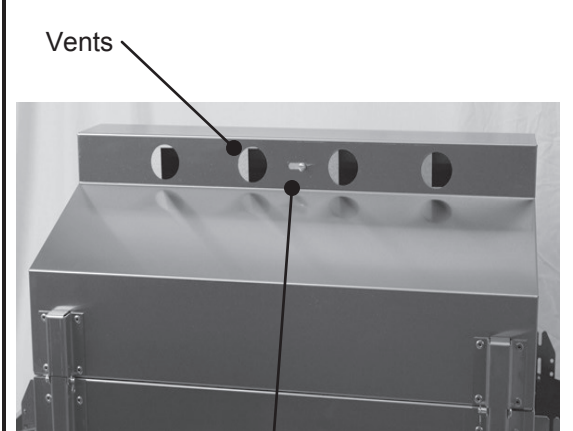

Vent Slide

# SDRIV4LDD Cart Assembly

## Tools Required For Assembly:

7/16" Wrench, 7/16" Socket Wrench with Extension, 3/8" Wrench.

**CAUTION:** Edges of some of the grill parts may be sharp, use care when assembling grill.

**CAUTION:** While handling the grill head be very careful not to damage the Venturi Tubes or the Ceramic Ignitor Insulator which protrudes from below the grill.

## CART HARDWARE

Carton contains the following components for the cart mounting:

Please check to be sure that all parts are included before proceeding. Contact your dealer or the factory if any parts are missing.

Long Legs	2	1/4-20 x 1/2" Carriage	1
Short Legs	2	Hub Caps	2
Lower Frame Brackets	2	Hose Retaining Ring	1
Lower Tank Brackets	2	1/4-20x1/2" Phillips Screw	18
8" Rubber Wheels	2	1/4-20x3/4" Hex Head Bolt	10
Axle 22 1/2"	1	1/4-20 Kev Nut	28
Axle Hitch Pins	2	10-24x1/2" Phillips Head	10
LP Tank Fastener	1	10-x24 Kev Nut	10
1/4—20 Wing Nut	1	10-24 Nylon Lock Nut	8

## Complete View of Cart Assembly

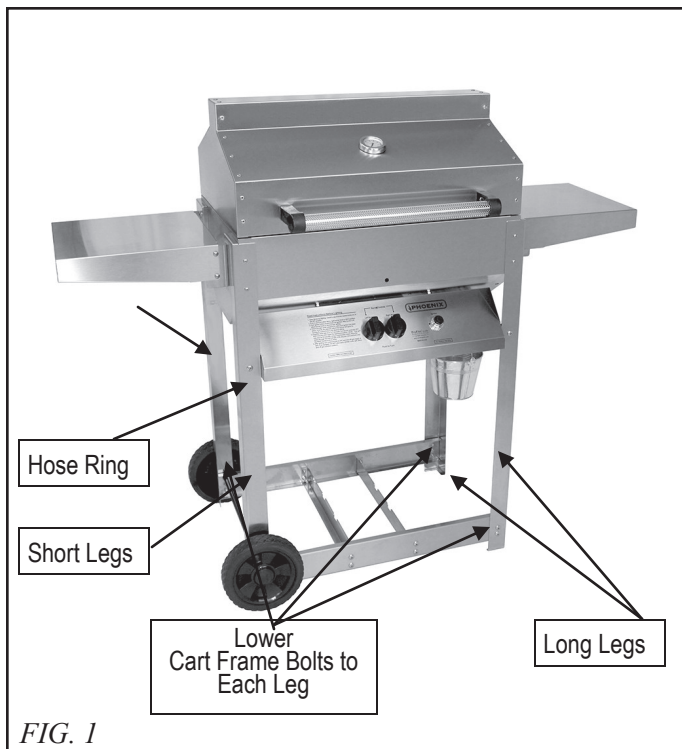

## Step 1: Leg Assembly (Fig 2)

1. Tip the grill head bottom on end as shown in (Fig. 2). (TIP: work on protected area such as carpet, tarp or one of the boxes to protect grill finish.)
2. Attach the (2) long legs to the right end of the grill's bottom pit. Use (2) 10-24 x 1/2" Phillips Head Screws for each leg. Insert screws from outside of grill pit and fasten with 10-24 kev nuts.
3. Flip the grill over and attach the (2) short legs to the left side of the grill pit bottom. Use (2) 10-24 x 1/2" Phillips Head Screws for each leg. Insert screws from outside of grill pit and fasten with 10-24 kev nuts. **Note: When attaching front legs make sure the control panel tab is tucked behind the front legs as shown in (Fig. 3) The valve stems must be seated properly in the venturi tubes as shown in (Fig. 4) before tightening.**
4. Flip grill upside down and attach the lower frame brackets to the front and back of the grill with (4) 1/4-20x1/2" with Hex Head Bolts for each bracket as shown in (Fig. 5) with (4) 1/2-20 Kev nuts.
5. Next attach the lower tank brackets from front to back to the lower frame brackets as shown in (Fig. 6)**Note: Angled edges face out.**
6. Tighten all fasteners with 7/16" & 3/8" wrench before moving on to next steps.

**FINGER TIGHTEN ALL BOLTS UNTIL LOWER BRACKETS ARE ATTACHED.**

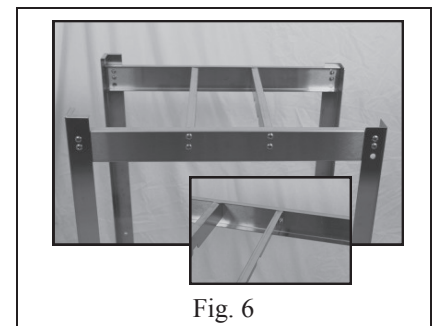
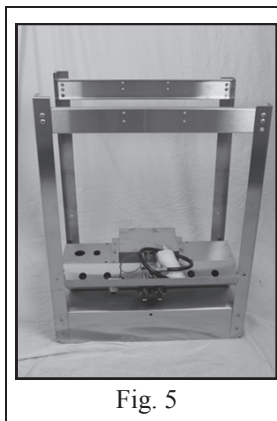
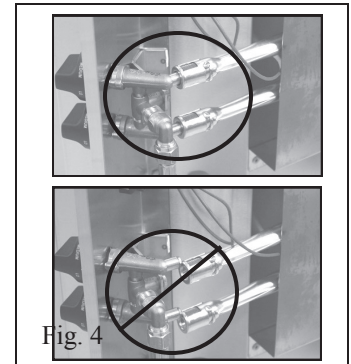
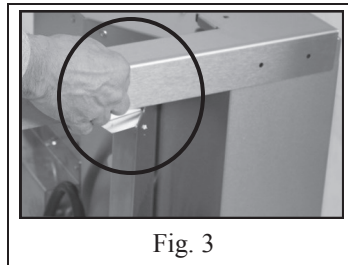
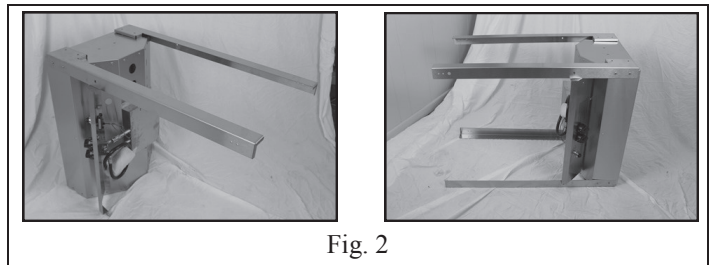

### Step 2: Installing LP Tank Fastener

1. Located on the underside of grill pit, mount the LP tank fastener to the underside of the heat shield with (2) 10-24 x 1/2" Phillips Head Screws as shown in (Fig. 7).
2. Secure the LP tank fastener from the inside of the heat shield with (2) 10-24 Kev Nuts as shown in (Fig. 8) and tighten with 3/8" wrench.

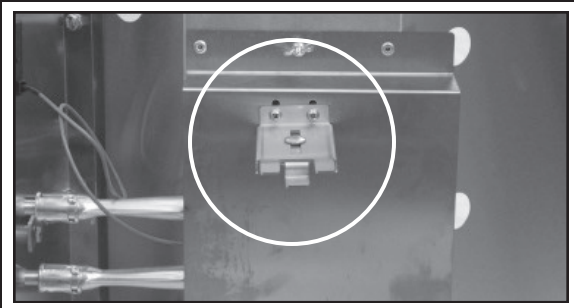

Fig. 7

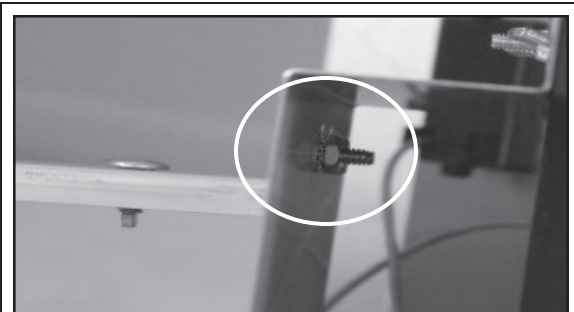

Fig. 8

### Step 3: Axle and Wheel Assembly

1. Install (1) axle hitch pin into the small end hole of the axle. Slide (1) wheel onto the axle, hubcap side out.
2. Slide open axle end through the short leg holes and install remaining wheel and hitch pin. Install hubcaps after the cart bolts are completely tightened.
3. Stand grill upright to seat legs and tighten all bolts and nuts making legs and frame rigid.

**Note: Recheck all fasteners for tightness.**

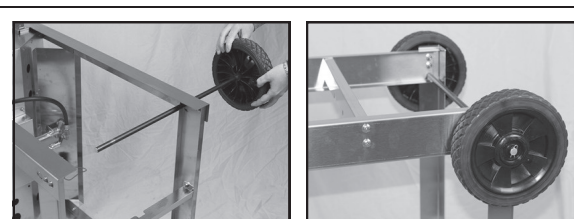

Fig. 9

### Step 4: Installing the Drop Down Shelves

#### Mounting Bracket to Grill

1. Attach brackets to grill using 1/4-20 x 3/4" Hex Head Bolts and 1/4-20 Kev Nuts to each side of your grill as shown in (Fig. 10) Use (2) bolts and kev nuts per bracket.

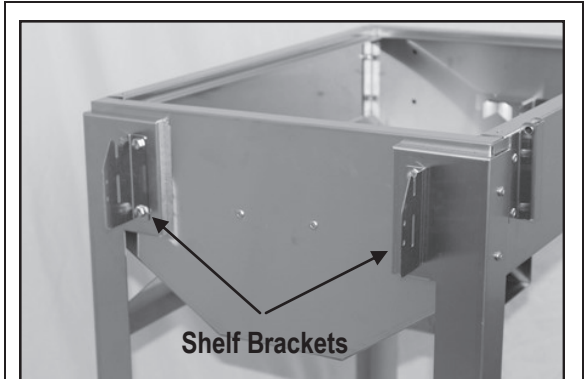

Fig. 10

#### Mounting Shelf to Bracket

2. Place the left bottom shelf post into the left bottom bracket slot as shown in (Fig. 11). Gently spread the shelf apart to insert the right bottom shelf post into the right bottom bracket slot. Secure bottom posts with 10-24 Nylock Nut—making sure nuts are snug but do not restrict the movement of folding and unfolding of the shelf.

**Note: Top posts on shelf do not use nuts.**

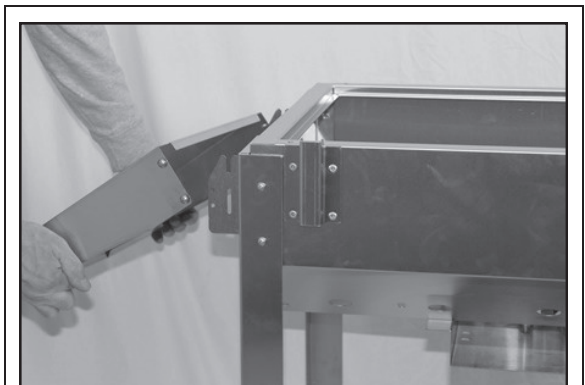
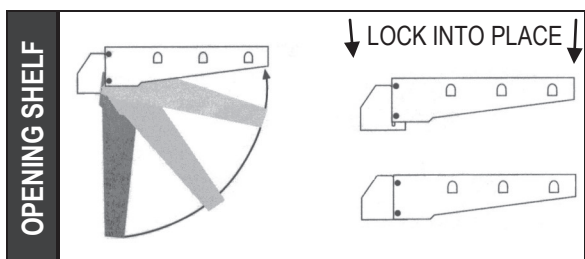
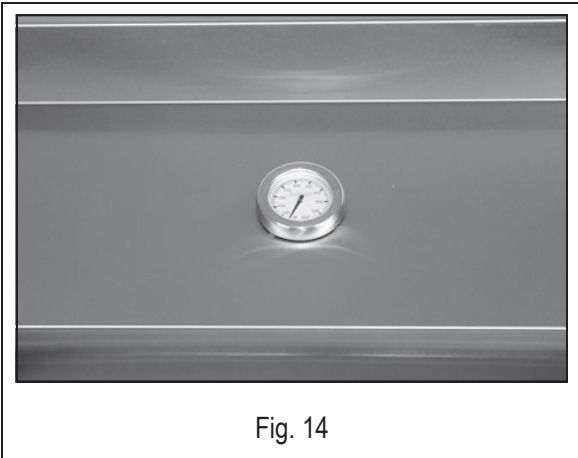
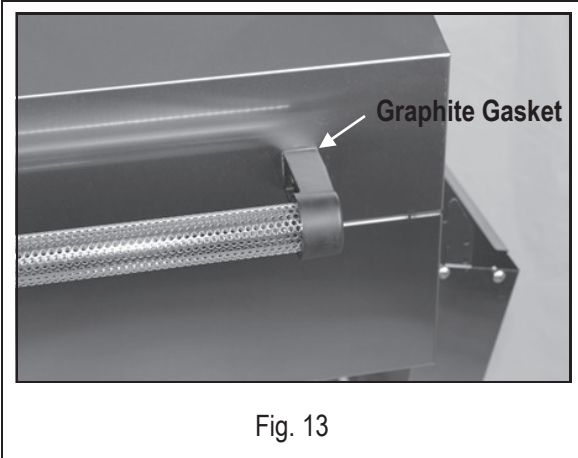
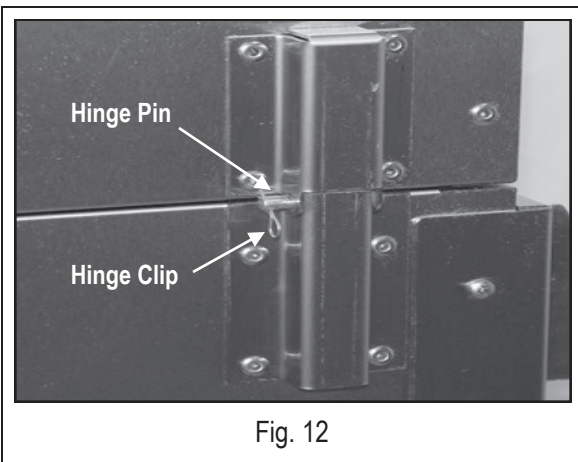

Fig. 11



### Step 5: Lid Assembly to Fire Pit

1. Position the top and bottom hinges together and complete assembly using the 2 hinge pins and hinge clips (Fig. 12).
2. With the lid open attach the handle to the lid using (2) 1/4-20 x 1" hex bolts, 1/4" flat washers, graphite gaskets and 1/4-20 kep nuts. The gaskets are positioned between the handle end caps and grill lid. (Fig. 13)
3. Install the thermometer through the hole in the center of the lid and snug the thermometer with thumb bolt. (Fig. 14) **Do Not Over Tighten.**



### Step 6: Install Drip Pan and Drain Valve

1. With the lid open, insert drip pan into place using the lift tabs on each end. Line up the drain pipe with the hole in the bottom of the pit.
2. Once drain pipe is in place resting in the bottom of the pit thread the brass valve onto the drain pipe hand tightened only. **Note: You may need to remove the valve occasionally for cleaning.** (Fig. 15)
3. Hang the drain bucket on the brass valve and open valve. (Fig. 16)

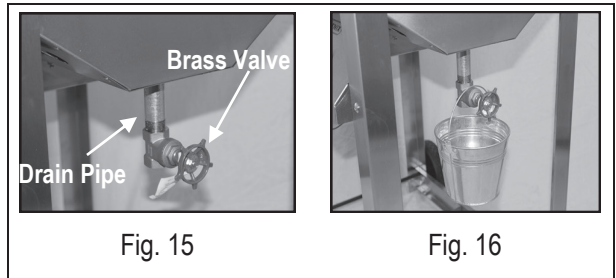

### Step 7: Installing Cooking Grid

1. Place the mesh stainless steel cooking grid into the grill as shown in (Fig. 17).

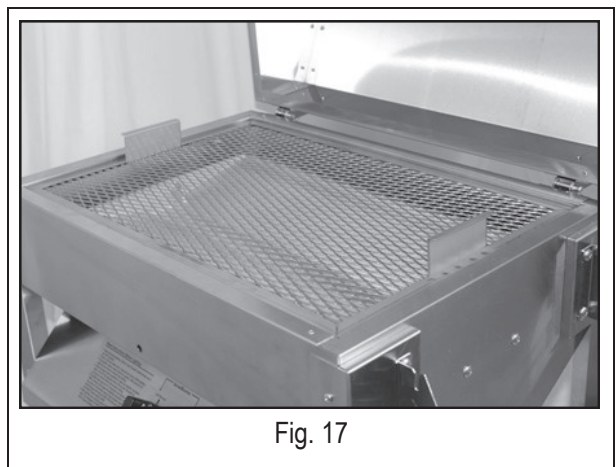

### Step 8: Installing & Locking LP Tank Into Place

1. Place LP tank into slots in support shelf on the bottom of grill cart as shown in (Fig. 18).
2. Slide the LP tank lock down as shown in (Fig. 19) and tighten wing nut to lock in place.

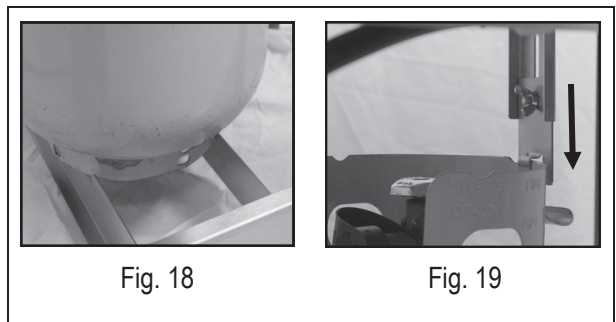

# Gas and LP Tank Connections

## CONNECTING THE LP CYLINDER (Fig. R)

Install the gas cylinder in the back of your grill, with the open side of the tank valve collar pointing towards the square hole in the tank enclosure. Ensure that all hoses, fittings and regulators are properly protected from heat and accidental damage. Hoses can be burned or chafed if routed improperly. (See Hose and Regulator, page 3). Be sure all burner control valves on the grill are turned "OFF". To connect hose and regulator to cylinder turn coupling nut clockwise as shown in diagram below (Fig. R). (To remove the quick connect coupling nut, turn counter clockwise). Your Phoenix Grill comes with a Type I connector, also known as a "Quick Connect Valve" connection. It has a large plastic (coupling nut) that screws onto the propane tank gas outlet. **Note: Your Phoenix Grill does not come with a propane tank. Therefore, be sure the tank you purchase has this type of hook-up. Also, the cylinder you use must be equipped with a listed overfilling protection device. This can be identified by the triangular hand wheel. (See diagram below and page 2 of these instructions).**

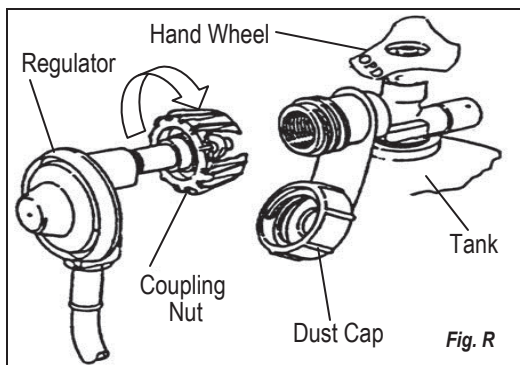

## REMOVAL OF THE LP CYLINDER

1. Close the LP tank valve.
2. Unscrew the QCC-1 plastic nut BY HAND COUNTER-CLOCKWISE (to the left).
3. Raise the tank locking bar
4. Lift cylinder off.

**⚠ WARNING: If you exchange your LP cylinder, make sure you get a similar tank in return.**

**⚠ Your exchanged LP cylinder must be equipped with a QCC-1 or type-1 valve and an OPD (Overfilling Prevention Device). Other LP cylinders may not be compatible with your grill connection.**

## LP-GAS CYLINDER FILLING & HANDLING

A qualified attendant, who fills the cylinder by weight, should fill your LP cylinder at an authorized LP gas dealer. Improper filling is dangerous.

- When transporting the LP cylinder be sure the plastic dust cover is in place over the valve. This keeps the valve threads free of dirt.
- Do not handle the cylinder roughly.
- Do not apply heat directly to the cylinder.

## LP-GAS CYLINDER FILLING & HANDLING (Continued)

- Air must be removed from a new LP cylinder before the initial filling. Your LP dealer is equipped to do this.
- The cylinder supply system must be arranged for vapor withdrawal
- Always keep and store cylinders in an upright, secure position.
- Use this grill outdoors in a well-ventilated area. Do not use in a garage, building, or any other enclosed area.
- Storage of an outdoor cooking gas appliance indoors is permissible only the cylinder is disconnected and removed from the outdoor cooking gas appliance.
- If the outdoor cooking appliance is not in use, the gas must be turned off at the supply cylinder.
- Cylinders must be stored outdoors out of reach of children and must not be stored in a building, garage or any other enclosed area.

## LP GAS CYLINDERS SAFE HANDLING TIPS

- Liquid propane (LP) gas is a petroleum product as are gasoline and natural gas. LP gas is a gas at regular temperatures and pressures. Under moderate pressure, inside a cylinder, LP gas is a liquid. As the pressure is released, the liquid readily vaporizes and becomes gas.
- LP gas has an odor similar to natural gas. Be aware of this odor.
- LP gas is heavier than air. Leaking gas collects in low areas and prevents dispersion.
- To fill, take the LP cylinder to your local authorized LP dealer, or look up "gas-propane" in the yellow pages to find authorized dealers.
- A new LP cylinder must be purged before the first filling. Your LP dealer is equipped to do this.
- An LP cylinder must be transported, installed and stored in an upright position.
- LP cylinders should not be handled roughly.
- Never store or transport an LP cylinder where the temperatures can reach 125 degrees. Never leave an LP cylinder in a car on a hot day.
- Always close the LP cylinder valve before disconnecting the tank or any other gas fitting.
- Always close the LP Cylinder valve after using grill.
- Do not use a damaged LP cylinder. Dented, rusty or a damaged LP cylinder valve may be hazardous and should be replaced with a new one immediately.









- **Never fill the LP cylinder beyond 80% full.**
- **Do not store a spare LP gas cylinder under or near the grill.**

***If this information is not followed exactly, a fire causing death or serious injury may occur.***

# Leak Testing and Lighting Your Grill

## Leak Testing

-  LEAK TEST ALL GAS CONNECTIONS BEFORE USING YOUR GRILL.
-  DO NOT SMOKE WHILE LEAK TESTING.
-  DO NOT LEAK TEST WITH A MATCH OR OPEN FLAME.
-  DO NOT USE A GRILL THAT IS LEAKING GAS.
-  YOU SHOULD TEST FOR GAS LEAKS EVERY TIME YOU DISCONNECT AND RECONNECT A GAS FITTING.
-  PERFORM A LEAK TEST EVEN IF YOUR GRILL WAS DEALER OR STORE ASSEMBLED.
-  DO NOT IGNITE BURNERS WHEN LEAK TESTING.



### LEAK TESTING

1. For LP models, leak test with a full propane cylinder.
2. For systems other than self-contained LP cylinders:
  - A. The grill and its individual shut-off valve must be disconnected from the gas supply piping systems during any pressure testing of that system at test pressures in excess of 1/2 psi (3.5 kPa).
  - B. The grill must be isolated from the gas supply piping system by closing its own manual shut off valve during any pressure testing of the gas supply piping system at pressures equal to or less than 1/2 psi (3.5 kPa).
1. Grill burner control valves should be turned off and the gas turned on at source.
2. Apply soap solution to all gas connections.  
**To make soap solution, mix together equal amounts of liquid detergent and water.**
3. Soap bubbles will appear if there is a leak.
4. Tighten the connection to make proper seal. And recheck for soap bubbles.

 **If you cannot stop a gas leak by tightening, turn gas supply off. Take leaking joint apart, clean it, reconnect and test again. If leak persists, contact the dealer or gas utility.**

 **A gas system MUST be tested yearly, or whenever the LP cylinder or any other gas system part is replaced.**

## Lighting Your Grill

-  ALWAYS OPEN GRILL BEFORE LIGHTING THE BURNER.
-  DO NOT LEAN OVER AN OPEN GRILL. KEEP YOUR HEAD AND BODY AT LEAST ONE FOOT AWAY WHEN LIGHTING THE GRILL.
-  IF BURNER DOES NOT LIGHT, IMMEDIATELY TURN BURNER CONTROL KNOBS TO OFF. WAIT FIVE MINUTES TO LET GAS CLEAR BEFORE YOU TRY LIGHTING AGAIN.

### LIGHTING

1. Open Lid. Examine the interior to be sure it appears normal.
2. Turn burner control knobs to OFF position.
3. Turn gas ON at LP tank or supply. **Wait 5 seconds for regulator to set itself.**
4. Turn either burner control knob to HIGH, press and hold the ignitor button until one half of the burner lights. Turn the other burner control knob to HIGH and the other half of the burner will light automatically.
5. The burner flame should be a hard blue cone with a minimum amount of yellow flame, although some yellow dust flicks may occur.

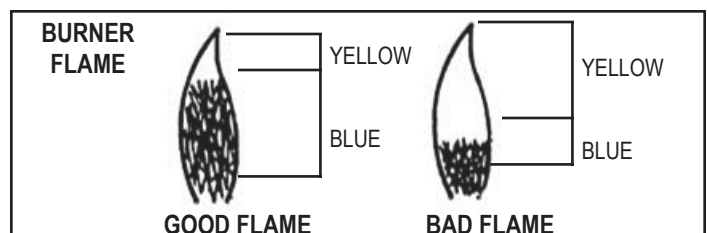

6. Close the grill lid and pre-heat the grill for five to ten minutes before cooking.

**WARNING: If burner fails to light, turn control knobs OFF and wait five minutes for gas to clear and try lighting procedure again.**

**To light burner manually:** With the grill lid opened, open valve at propane tank or natural gas supply. Turn the right burner control to "HIGH" and insert lit match or lighter into match hole located in the lower section of the fire pit and to the right of the control panel.

**To Extinguish your grill:** Turn each burner control knob to OFF position. Turn gas supply OFF at the source.

# Maintenance

## Annual Maintenance

After a period of nonuse or to keep your grill in top operating condition, you should perform the following maintenance procedures to keep the grill ready for instant use and for your safety.

- Do not obstruct the flow of combustion and ventilation air.
- Clean inside the grill head. Remove the burner/venturi assembly and cover the valve orifices with a piece of aluminum foil to keep out dirt. Brush inside bottom and sides with a stiff wire brush to remove built-up grease and debris. **Be careful not to damage the Ignitor or Collector Box.**
- Test the Ignitor for a good spark. (See Electronic Spark Ignitor System in the General Maintenance section.)
- The stainless steel burner may be brushed lightly with a stiff laundry brush. Any clogged flame holes may be opened using a thin wire. Use the supplied venturi cleaning brush or a bottle brush, pipe cleaner to clean out the venturis. (See Flashback in General Maintenance.)
- Clean the Control Panel, Side Shelf Supports, Lid Handle Spacers, Lower Cart Frame, Posts with a mild detergent soap and warm water solution. For the column use a mild detergent soap and water, Windex is also great to clean the column and grill lid facing. **Do Not Use cleaning agents such as bleach, powdered cleansers, steel wool pads or caustic solutions like oven cleaners because they will damage the surfaces.**
- Inspect the hose and gas fittings. Remember to leak check every time you disconnect and reconnect a gas fitting.
- Keep the ventilation openings of the LP cylinder enclosure free and clear from debris.

**Warning:** Check the hose before each use of the grill for nicks, cracking, abrasions or cuts. If the hose is found to be damaged in any way, do not use the grill. Replace using only **MHP** authorized replacement hose.



## General Maintenance

### Flashback

In some areas of the country, spiders and other insects build nests, lay eggs and spin webs in the grill's venturi tube or valve orifice. This obstructs the full flow of gas to the burner. Some gas backs up resulting in a "**Flashback**" - a fire in the venturi behind the control panel which could cause serious bodily injury or damage to your grill.

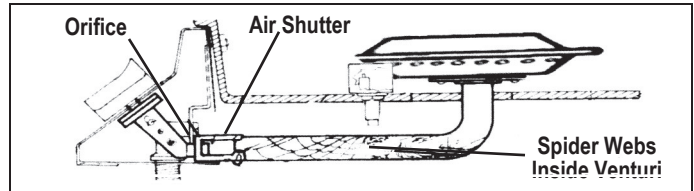

To remove spider webs and/or other obstructions, you must clean out the venturis. **This should be done routinely if the grill has sat idle for extended periods. Also, if you live in an area where spiders are plentiful, you should clean the venturis often, especially in the fall when there is an increase in egg sack production.**

To clean, be sure the grill is cold. Open lid and remove the cooking grid and the drip pan.

1. Remove the burner wing nuts holding the burner in place.
2. Lift burner and venturi assembly out. With supplied cleaning brush, a pipe cleaner or a flexible wire, clean out the venturi tube.
3. Remove hex head orifice with a 3/8" wrench. Clean Orifice hole and inner part of the valve with a toothpick. Be careful not to enlarge the orifice hole.
4. Check orifice receptacle in valve body.

When finished cleaning reassemble the complete unit.

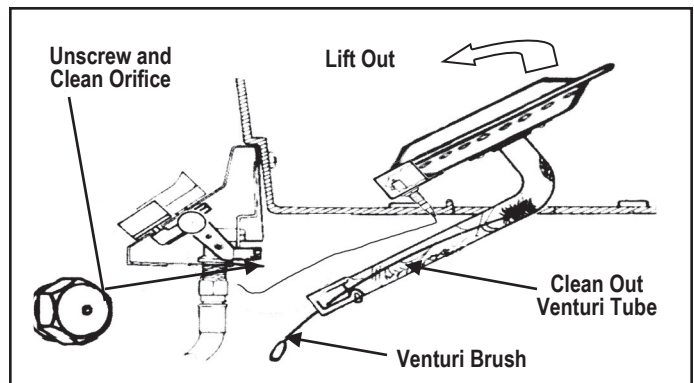



# Maintenance

## General Maintenance

### Ignitor System

If you experience an occasional “No-spark-No light” condition here’s a check list to troubleshoot the problem.

**1. Inspection.** WITH GAS OFF, position a mirror in front of the collector box and rotate the ignitor knob several times. Observe the condition of the spark. (Low light conditions are the best for seeing the spark.)

**A. If there’s a good spark,** but the grill won’t light, gas may not be flowing to the burner and into the collector box. The gas orifice or the venturi tube may be blocked. To clean, follow Flash-back” instructions.

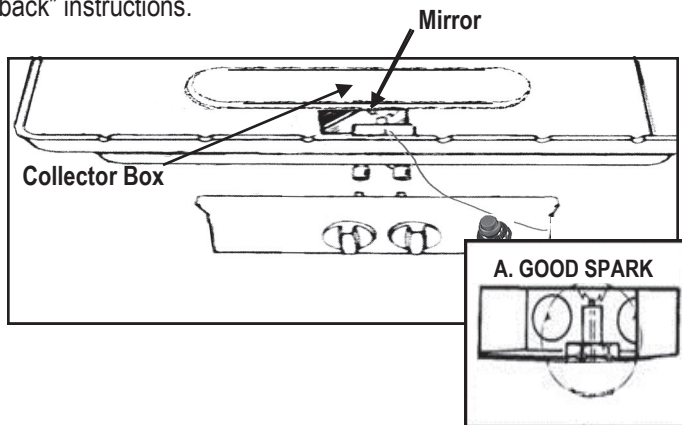

**B. If a weak spark arcs down around the ceramic insulator,** the battery should be changed and insulator should be cleaned. The insulator has a coating of grease or it is wet. Use an old tooth brush to break up the conductive electric path.

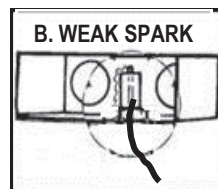

**2. If there is no spark the collector box.**

**A. Check the wire connections** at the ignitor and electrode under the grill.

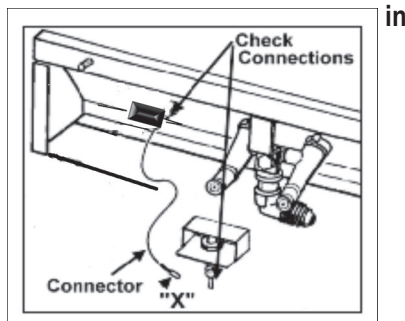

**B. Check spark.** Pull the connector wire from the collector box (see “X” Fig. S). Bring wire to bottom or top of control panel, hold about 1/8” away and operate the ignitor. Check for spark. If there is **no spark, first** replace the battery. If there still isn’t a spark replace the electronic ignitor. If there is a spark the electronic ignitor is OK, but the Collector Box/Electrode assembly should be replaced (the ceramic insulator could be cracked).

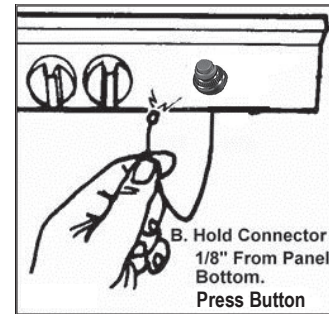

**C. Make sure ignitor button module is tight on the control panel.** If it is loose a good ground will not be attained.

### Electrode Replacement or Adjustment

The electrode inside the collector box is pre-set for optimum spark. The tip is 1/8” from inside surface of the collector box.

Check the gap of the new part before installing. Loosening and tighten the two jam nuts will move the electrode tip, set at 1/8”.

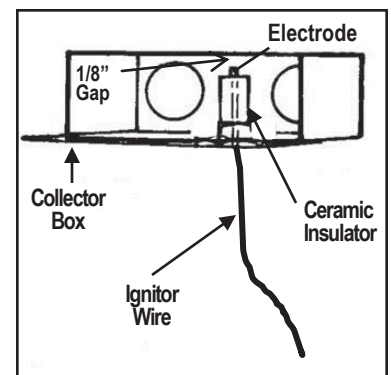

### Stainless Steel Cleaning

**Before Cleaning, determine which way the “grain” of the metal runs and always clean with the grain. NEVER USE STEEL WOOL PADS TO CLEAN STAINLESS STEEL.**

1. Routine cleaning is done with a warm soapy water applied with a sponge or soft cloth. Always rinse with clean hot water and wipe dry with a soft cloth. Glass cleaners like Windex also works well.
2. Stubborn stains can be removed with a mild non-scratching abrasive household powder. Add a small amount of vinegar to the scouring powder to increase its potency.
3. Commercial stainless steel cleaners and polishers also work well, such as MHP’s Stainless Steel Cleaner (Part #SSC).

**Note: The stainless steel will turn a mild gold patina from the grill’s heat. This is normal.**

## Cooking Tips

### Cooking Tips For Your New Phoenix Grill

Your new Phoenix eliminates flare-ups because the cooking surface is shielded from direct flame contact by a drip pan. **For best results we recommend that all preheating, grilling, smoking, baking and steaming be performed with the lid closed!**

 **WARNING: ALWAYS LIGHT YOUR GRILL WITH THE LID OPEN.**

#### GETTING STARTED

Before you use your grill for the first time be sure to read and thoroughly understand all grill safety, lighting, locating, operating and maintenance procedures found in this book.

**We recommend you “break-in” your grill by cooking the first 2 or 3 times at medium or low temperature settings. This allows the drip pan to “season/break-in”. Please note: as long as the grease can flow into the grease bucket it is not necessary to clean the drip pan after each use. Clean as needed or approximately every 10 uses.**

**After each use, we recommend you turn the control knobs to “HIGH” (with the lid closed) and run the grill for approximately 10 minutes. This will allow the accumulated fats and greases to cook off, and avoid a possible flare up on the next use. HINT: The fats and greases are cooked off when no more smoke is flowing from grill vents.**

We recommend cleaning the cooking surface (cooking grid) before each use and before you light the grill. Simply run a wire brush front to back and side to side across the diamond shaped cooking surface. This can be performed with the cooking grid in place or you can remove the cooking grid for cleaning.

**The drip pan valve should be kept open while your grill is in use.** This allows the grease that drips from your food to continuously drain into the grease catch bucket. If you are cooking a small quantity of food or food with very little fat, you may not notice any grease collecting in the grease bucket. However, if you notice grease accumulating in the drip pan but is not running into the grease bucket, then either your drain valve is not open or the drip pan pipe is clogged. Don't attempt to clear the clog while the grill is hot! Wait until the grill has cooled, remove the cooking grid and run a stick down the drain pipe until the clog is cleared.

The only time the drip pan drain valve should be closed during grill use, is when you are steaming or smoking with liquid smoke. See below for steaming and smoking instructions.

The following grilling steaming, smoking and baking tips are provided as helpful guidelines. With experience you will find the cooking times and temperature control settings that best suit your taste. Please refer to page 15 for suggested cooking times.

#### GRILLING

Pre-heat your grill with both controls on “HIGH” for 15 minutes. If you are cooking hamburgers or steaks we recommend that you leave the temperature controls on the “HIGH” setting. Remember, for best results, cook all your foods with the lid closed. If you are cooking chicken, turkey, roasts, hot dogs or sausages we recommend that after preheating your grill on “HIGH”, turn both controls on the “MEDIUM” settings (half way between the high and low setting). To keep food warm, or to further slow the cooking process, you may try running only one side of the grill and warming or cooking on the opposite side. Or you may try cracking the lid (with a wood spacer) to let out heat.

#### BAKING

Pre-heat with both controls on “HIGH” for 10 minutes. Then set your controls to the following setting that most closely matches the temperature you want to achieve. (Hint: the lid thermometer will help to more accurately set your control).

Low Setting	350° Degrees to 400° Degrees
Middle Setting	400° Degrees to 450° Degrees
High Setting	450° Degrees to 500° Degrees

#### SMOKING

**Caution:** Before you proceed, make sure that your grill is on a solid level surface. Check to see that your drip pan is relatively clean. Smoking or steaming with a dirty drip pan can affect the taste of your food. To clean your drip pan, simply unscrew the drain valve and lift out the drip pan. Never attempt to clean the drip pan while the grill is hot or if the grill is in use. A putty knife or scraper works well for cleaning out the drip pan.

#### WOOD CHIP OR CHUNK SMOKING

Place the desired amount of wood in a wood chip container. You can fabricate your own container(s) by folding heavy gauge aluminum foil into an open square or purchase a MHP stainless steel smoker box (part #SDSSST) from your Local Dealer. Place one or more containers directly on top of the drip pan located under the cooking grid. Do not place the container in the middle of the drip pan. For best results place the container halfway between the center and the edge of the drip pan. Heat the grill on “HIGH” for 30 minutes, or until you detect smoke, before you place your food on the grill. Cook to desired taste.

## Cooking Tips

### LIQUID SMOKE GRILLING

Make sure your drip pan is relatively clean, see page 14 for drip pan removal cleaning. Close the drip pan drain valve and fill the drip pan with water (be sure not to overfill your drip pan). Add several ounces of liquid smoke. Experience will dictate how much liquid smoke is required to suit your taste. Heat the grill with both controls on "HIGH" for 20 to 25 minutes. Keep controls on the "HIGH" settings and cook to desired taste. Add more water and liquid smoke if you are cooking for an extended period of time. Do not attempt to move your grill with water in the drip pan, and wait until your grill has cooled before draining out any remaining water.

The following quality MHP accessories are designed to make your smoking experience more convenient and enjoyable. See these products and a complete list of accessories for your new Phoenix grill on pages 18 and 19.

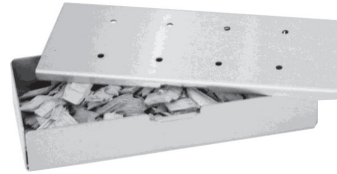

**Stainless Steel Smoker Box**

### STEAMING

**CAUTION:** Before you proceed, make sure that your grill is on a solid surface. Check to see that your drip pan is relatively clean, see "smoking" instructions for drip pan removal and cleaning. Close the drip pan drain valve and fill the drip pan with water (be sure not to overfill). Heat the grill with both controls on "HIGH" for 20 to 25 minutes. Keep controls on the "HIGH" setting and cook to desired taste. Steaming is good for foods as oysters, clams, lobsters, and shrimp, etc. Do not attempt to move your grill with water in the drip pan, and wait until your grill has cooled before draining out any remaining water.

## COOKING TIMES

### A Quick Reference

			Control Setting
Chicken	3 lb. Whole Chicken	90 Minutes	LOW
Chicken Legs or Thighs		45-60 Minutes	LOW
Pork Chops	1 Inch Thick	15 Minutes Each Side	MEDIUM
Italian Sausage		40 Minutes	MEDIUM
Pork Sausage	Patty	8 Minutes Each Side	MEDIUM
Pork Ribs		60 Minutes	MEDIUM
Prime Rib		2 1/2 Hours (Use Meat Thermometer)	MEDIUM
Vegetables	All	30 Minutes	LOW
Biscuits	Canned	7 Minutes Each Side	LOW

## TROUBLE SHOOTING GUIDE

If you are having difficulty with your grill, follow this guide to solve some common problems.

### **Problem #1: BURNER(S) WILL NOT LIGHT OR THE GRILL DOES NOT GET HOT ENOUGH.**

<b><u>PROBABLE CAUSE</u></b>	<b><u>SOLUTION</u></b>
A. Propane Cylinder Almost Empty.	Have Propane Cylinder Filled.
B. Propane Cylinder Valve Not On.	Turn Valve On. Turn Counter-Clockwise to Open.
C. Kink In The Gas Hose.	Reposition The Propane Cylinder To Straighten The Hose.
D. Burner Holes Clogged.	Clean With Small Wire or Round Toothpick and Sire Brush the Entire Burner. See “ <b>Care and Maintenance</b> ” Section For Further Instructions.
E. Venturi Blocked.	Clean Venturis. Refer to “ <b>Venturi Cleaning</b> ” Section
F. Venturis Not Sealed.	Refer to “ <b>Prior to Use</b> ” Section
G. Orifices In Valve Outlet Plugged.	Clean Orifices ( <b>small hole in valve outlet</b> ).
H. Regulator And/Or Valve Defective.	Take Complete Hose, Valve and Regulator Assembly to a Servicing LP Gas Dealer for Inspection.
I. Ignitor Not Working.	Check For Proper Electrode Gap. Make Sure All Wires Are Connected and None Broken. Check Ceramic for Cracks.

### **Problem #2: FLASHBACK (fire in venture or control panel area). IF FLASHBACK SHOULD OCCUR, SHUT CONTROLS OFF THEN TURN VALVE OFF AT PROPANE CYLINDER.**

<b><u>PROBABLE CAUSE</u></b>	<b><u>SOLUTION</u></b>
A. Venturi Blocked	Clean Venturis. Refer To “ <b>Venturi Cleaning</b> ” Section.
B. Venturis Not Sealed.	Refer To “ <b>Prior To Use</b> ” Section.
C. Valve Out Of Alignment.	Adjust Valve So The Valve Outlets Are Pointing Straight Into The Venturis.
D. Burner Holes Clogged.	Clean With Small Wire or Round Toothpick and Wire Brush the Entire Burner. See “ <b>Care and Maintenance</b> ” Section For More Information.
E. Windy Day	Shield Grill From The Wind.

## Parts Information

QUANTITY	PART NO.	DESCRIPTION
1	SDBASE	Grill Base (SDWELDD & SDRIVDD)
4	KKWL3	Locking Casters (SDWELDD & SDRIVDD)
1	PFCFT	Column Front (SDWELDD & SDRIVDD)
2	PFCSD	Column Sides (SDWELDD & SDRIVDD)
1	SDHOOD	Hood (Lid) (SDWELDD)
1	SDRVHOOD	Riveted Hood (Lid) (SDRIVDD & SDRIV4LDD)
1	GGSH	Stainless Steel Handle
2	GGSHC	Handle End Caps
2	GGSHG	Handle Graphite Gaskets
1	GGTG4	Temperature Gauge
1	SDPIT	Fire Pit (SDWELDD)
1	SDRVPIT	Riveted Fire Pit (SDRIVDD & SDRIV4LDD)
2	PFHH	Hood (Lid) Hinge
2	PFPH	Fire Pit Hinge
2	SDHP	Lid Hinge Pins
1	SDCV-430	Vent Control
2	PFDPBKT	Drip Pan Bracket
1	SDFABCP	Control Panel (SDWELDD & SDRIVDD)
1	SDRIVCONT	Control Panel (SDRIV4LDD)
2	SDPF80-5	Control Knobs
1	SDCPLBL-P	Control Panel Label (SDWELDD & SDRIVDD)
2	PFSB-A	Right Side Shelf Brackets
2	PFSB-B	Left Side Shelf Brackets
2	SDSSDD	Stainless Steel Side Shelves
1	SDSUP	Column Support (SDWELDD & SDRIVDD)
1	OBS-SD	Stainless Steel Burner
2	SDV34	Venturi Tubes
2	GGLPP1	Burner Hitch Pins
1	IG5	Gas Collector Box
1	GGEIB	Electronic Ignitor
1	GGEIBPB	Ignitor Push Button
1	HHVLV28SD	Propane Gas Grill Valve (For Propane Models)
1	HR6B	Propane Gas Hose and Regulator (For Propane Models)
1	HHVLV32SD	Natural Gas Grill Valve (For Natural Gas Models)
1	ASCPL1	12' Quick Disconnect Hose (For Natural Gas Models)
1	SDSSDT-A	Cast Aluminum Drip Pan
1	SDDV	Drip Pan Drain Valve
1	SDGB	Grease Collector Bucket
1	VTC	Venturi Tube Cleaning Brush
2	GGWL	8" Wheel (SDRIV4LDD)
2	GGAWP	Axle Wheel Pin (SDRIV4LDD)
2	GGHC	Hub Cap (SDRIV4LDD)

# PHOENIX GRILLS

UPGRADES AND ACCESSORIES  
FOR ADDED  
VERSATILITY, CONVENIENCE AND OUTDOOR  
COOKING ENJOYMENT.

## Sear Magic® Infrared Burner #PFMGSEAR

State-of-art cooking system gives you time saving grilling at high temperature in seconds. The overall intense heat seals in meat juices for better flavor. Stainless Steel construction and mounts easily to the side of you grill. Our patented reversible cooking grid included. Electronic ignition for fast starts. Removable drip pan for easy clean-up. 22,000 BTU's and is available in Natural or Propane Gas.

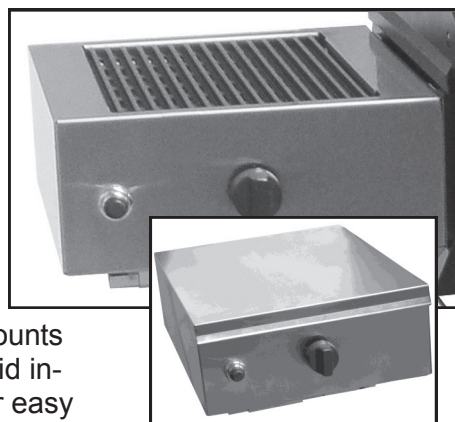

### Heavy Aluminum Griddle #SDAG

Heavy-duty griddle perfect for breakfast French toast, eggs, bacon, etc. 16" L x 12" W

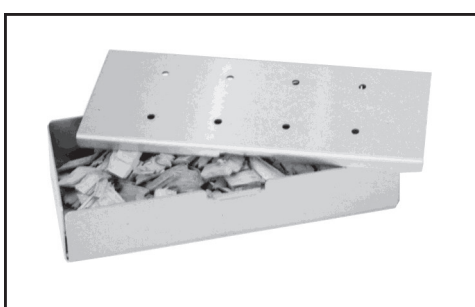

### Stainless Steel Smoker Box #SSST

Stainless steel smoker box with cover. For use with all grills. Insert moistened wood chips for your favorite smoke flavor. 8-3/4" L x 3-1/2" W x 1-1/2" D

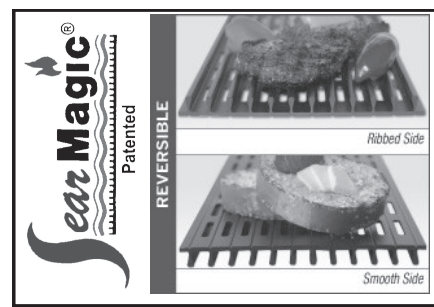

### Anodized Aluminum Grid #SDGRIDS

Reversible rust-free anodized cooking grid that heats up faster and spreads heat more evenly. Wide-ribbed side for steaks, chops, etc. and flat side for cooking delicate foods. 16 1/2" x 8"

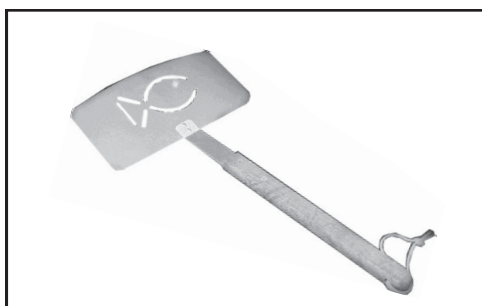

### Fish Spatula #FS1

Stainless steel fish spatula with genuine rosewood handle. 18-1/2" L x 10" wide spatula



### Super Flipper #SF1

Stainless steel super flipper. The ultimate spatula tool, specially curved for perfect flips every time. 18" overall length.



### Wire Cleaning Brush #WB3B

Brass bristle brush with scraper, wood handle and leather tong for hanging. 18" overall length.

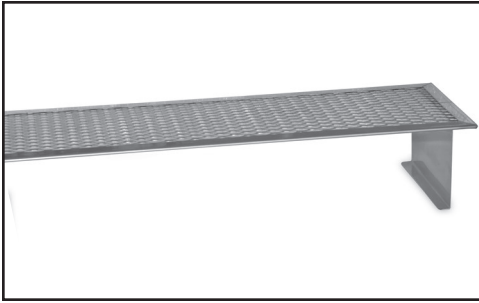

**Secondary Cooking  
Surface/Warming Rack  
#SDSCS**

More than a typical warming rack. This elevated surface cooks at lower temperatures for added flexibility. 24" W x 8" D x 4 1/4" H

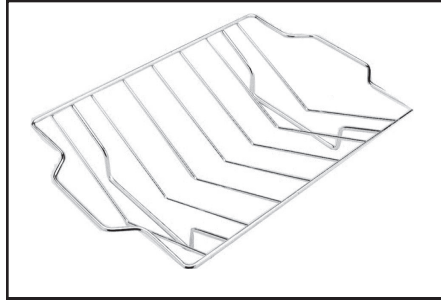

**Roast Holder  
#RR3**

Holds roasts, ham, fowl so heat circulates evenly around meat for thorough balanced cooking. Made of nickel-plated steel. 15-1/4" L x 10-1/2" W

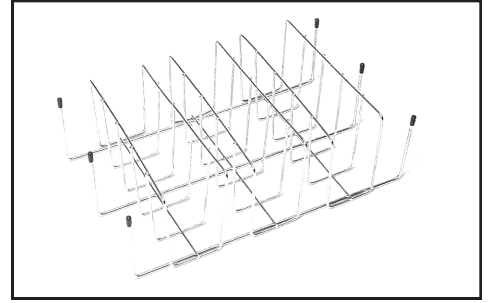

**Rib/Potato Rack  
#RR2**

Chrome plated accommodates 6 racks of ribs and 6 potatoes. 12" L x 7-1/4" W

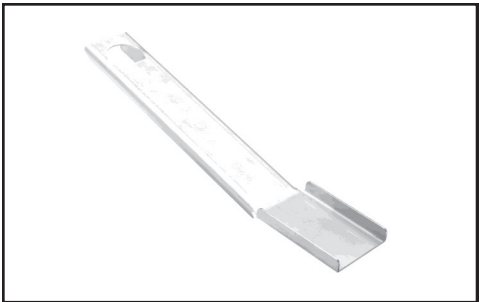

**Stainless Steel Scraper  
#SDDPS**

Unique rust-free designed drip pan scraper for Phoenix and Hollard Grills. Hanging hole for easy storage.

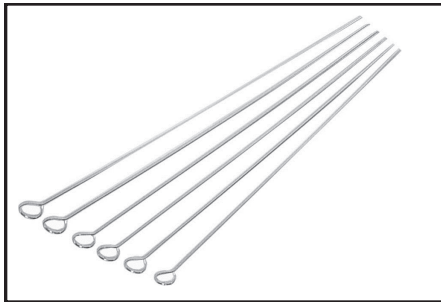

**Skewer Set  
#SR7B**

6-piece chrome plated skewers designed so food does not rotate. 19-1/2" long.



**Stainless Steel Cleaner  
#SCC**

Specially formulated for MHP stainless steel grills. 8 oz. bottle.



**Mid-Length Cover  
#GGCVPREM**

Premium quality polyester lined vinyl with E-Z on/off Velcro tabs. Fits Scottsdale Grill with two (2) side shelf. 60" left to right, 20" front to back and 24" top to bottom.



**Full-Length Cover  
#CV4PREM**

Premium quality polyester lined vinyl with E-Z on/off Velcro tabs. Fits Scottsdale Grill with two (2) side shelf. 60" left to right, 20" front to back and 42" top to bottom.

## Professional Quality Products For Your Backyard



**PHOENIX**

**GRILLS**

Produced by ProFire Grills  
A Division of Modern Home Products Corp.

5565 North 124th Street • Butler, Wisconsin 53007  
Phone: 262.781.4657 • 888.761.4657  
Fax: 262.781.3965 • 888.781.3965  
Email: [info@profiregrills.com](mailto:info@profiregrills.com)  
Web Site: [www.newphoenixgrills.com](http://www.newphoenixgrills.com)

**MHP IS YOUR COMPLETE SOURCE FOR GRILLS, LAMPS, PARTS & ACCESSORIES**

**Modern  
Home Products**  
Corporation

**MHP**  
OUTDOOR GRILLS

**ProFire® Grills**  
Perfection by Design

**PHOENIX**  
GRILLS

**BRAVO**

**MHP**  
GRILL PARTS

*Everglow*  
GAS LAMPS & TORCHES

*Celebrating 60 Years in Business*