



# WNK GAS GRILL HEAD

## Assembly Manual



SCAN THE  
QR CODE FOR  
ASSEMBLY VIDEO

English

## ⚠ IMPORTANT SAFETY WARNINGS

The appliance is **FOR OUTDOOR USE ONLY**. It is not to be used inside a garage, other building or any type of enclosed area. Combustible materials should never be within 18 inches of the bottom, back or sides of your MHP Gas Barbecue Grill.

- The WNK Grill head is specifically designed to fit these MHP mounting options.
  - WC4 Four Legged Open Cart
  - MPP In-ground Post
  - MPB Patio/Deck Base
  - OCOL/OCOLB with OM Base
  - OCOL/OCOLB with OP Base
  - OCOL/OCOLB with OC Base
- The gas supply may be either LP or Natural Gas



**Make sure your base is assembled before continuing.** The base assembly instructions should be included with your base.

**Visit our website [mhpgrills.com/info/owners-manuals/](http://mhpgrills.com/info/owners-manuals/) for a complete list of assembly videos & manuals**

### ⚠ DANGER: IF YOU SMELL GAS







1. Shut off the main gas supply to the grill
2. Extinguish any open flame
3. Open lid
4. If odor continues, keep away from the grill and immediately call your gas supplier or your fire department. **Failure to follow these instructions could result in fire or explosion which could cause property damage, personal injury or death.**

### ⚠ WARNING: FOR YOUR SAFETY

1. Do not store or use gasoline or other flammable liquids or vapors in the vicinity of this or any other appliance
2. An LP cylinder not connected for use should not be stored in the vicinity of this or any other appliance.
3. Follow all leak-test procedures on page 10 of this manual carefully before using. Do this even if the grill was dealer assembled. **Do not test for leaks with a match or any open flame.** Do not try to light this grill without reading the "Lighting" instructions.

## 📦 BOXES/BAGS:

You should have the following boxes/bags containing the different parts and hardware needed to assemble your grill.

			OR				OR	
<b>GG-GRATE-SS</b> Briquette Grate				<b>WNK-SEAR-PK</b> SearMagic Cooking Grids		<b>WNK-LP</b> Control Panel for LP Gas Grill (includes hose and regulator)		<b>WNK-NAT</b> Control Panel for Natural Gas Grill
				<b>GG-SS-GRID</b> Stainless Steel Cooking Grids				
				<b>OWNER'S MANUAL BAG</b> Includes: • Owner's Manual • Temperature Gauge • Venturi Tube Cleaner • (2) Lid Pivot Pins • (2) Hitch Pins				
<b>GGDASK</b> Side Shelves Kit						<b>BRIQUETTE BAG</b> 67 Briquettes		<b>END CAPS/HANDLE</b> Includes hardware

## 🔧 TOOLS LIST:

				
<b>ADJUSTABLE WRENCH</b>	<b>3/4" COMBINATION WRENCH</b>	<b>7/16" COMBINATION WRENCH (2)</b>	<b>3/8" COMBINATION WRENCH</b>	<b>PHILLIPS SCREWDRIVER</b>

# ASSEMBLY PREPARATION



Choose a Location where you are going to set up your grill. Make sure there is enough room and you have a flat surface. Improper assembly may be dangerous. Please carefully follow the assembly instructions in this manual.

- Place the box facing up
- Remove the packaging material followed by the grill head components
- Set the components on a flat surface
- **Check to see if all components are included and that you have the appropriate tools to begin the assembly.** Remove all components and discard the box.



At this point you should already have your bottom casting attached to your mounting (See your mounting assembly manual for these steps).

Make sure your base is assembled before continuing. The base assembly instructions should be included with your base.

Visit our website [mhpgrills.com/info/owners-manuals/](http://mhpgrills.com/info/owners-manuals/) for a complete list of assembly videos & manuals



## STEP 1 INSTALLING THE CONTROL PANEL



**WNK-LP**  
Control Panel for LP Gas Grill  
(includes hose and regulator)



**WNK-NAT**  
Control Panel for Natural Gas Grill

### PARTS INCLUDED IN BOX:



**CONTROL PANEL ASSEMBLY**



**BRACKETS (2)**



**KEP NUTS (6)**



**PHILLIPS HEAD BOLTS (2)**



**BATTERY**



**PUSH BUTTON**



**KNOBS (2)**



**LP GAS HOSE & REGULATOR**  
Included with LP Gas Grills only (pre-attached)

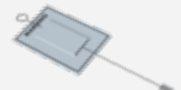

**VENTURI CLEANER**

### TOOLS NEEDED:



**PHILLIPS SCREWDRIVER**



**7/16" COMBINATION WRENCH**

### Remove the Burner

- Remove the grill burner by taking out the two small cotter pins located on the underside of the bottom grill casting (fig. a)
- Pull the burner up and out of the grill head (fig. b).

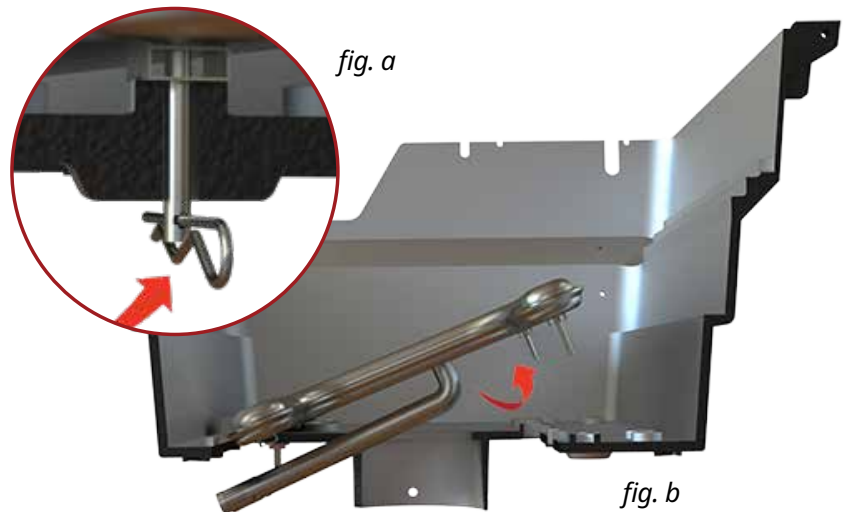

CONTINUED ►

## STEP 1 INSTALLING THE CONTROL PANEL, CONTINUED

### Attaching the Control Panel Assembly to the Front of the Bottom Casting

- Attach the complete control panel assembly to the front of the grill bottom casting with two 1/4-20 Kep Nuts and hand tighten
- Make sure the valve orifices on the control panel align with the burner venturi correctly and that the venturi tubes go over the valve orifices at least 1/4" to 3/8". (see Valve Stem Engagement below)
- Tighten all nuts using a 7/16" combination wrench



### Connecting the Control Panel Support Brackets

Two support brackets are connected beneath the control panel to the grill bottom casting for added support.

- Push 1/4 - 20 x 1-1/4" Phillips Head Bolts down through the grill bottom casting from the inside and continue through the back hole on the support brackets. Secure the brackets with 1/4 - 20 Kep Nuts.
- Attach the control panel to the support brackets by pushing up a 1/4 - 20 x 1/2" Phillips Head Bolt through the front hole of each support bracket and the lower lip of the control panel. Fasten brackets with a 1/4-20 Kep Nut.
- Tighten all nuts using a screwdriver and a 7/16" combination wrench

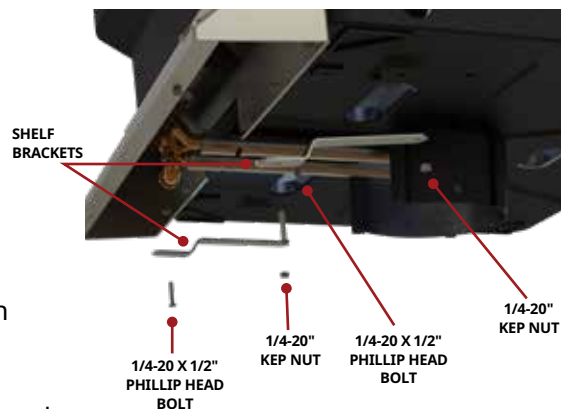

### Reinstall the Burner

- Drop the burner into the bottom of the grill casting making sure the venturi tubes go through the bottom opening.
- The burner leg pins should align with the predrilled holes in the bottom of the grill pit.
- Reattach small cotter pins onto the burner leg pins

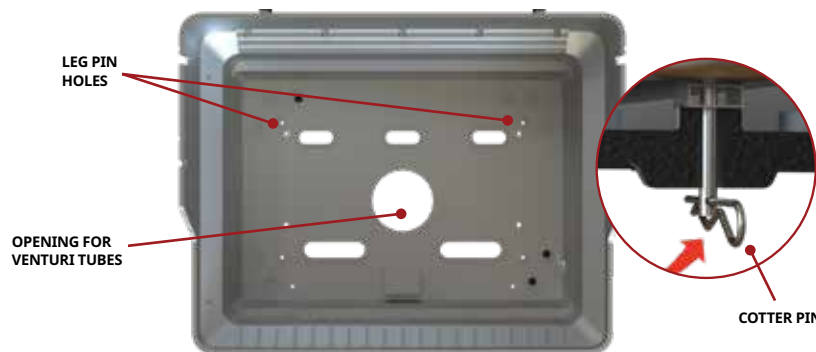

### Venturi Engagement

At the top end of each valve there is a tiny gas opening known as the orifice. Gas exits the orifice and enters a venturi where it mixes with air coming in from the side air shutter. The proper mixture of air and gas produces a clean blue flame at the burner.

- ⚠ Make sure the valve orifice on the control panel aligns with the burner venturi tube correctly. The orifice should fit into the venturi tube 1/4" to 3/8".



CORRECT



INCORRECT



## STEP 1 INSTALLING THE CONTROL PANEL, CONTINUED

### Ignitor Wire Connection

Attach the wire from the ignitor module, located behind the control panel, to the porcelain insulator found on the underside of the bottom casting.

- ⚠ Be careful not to crack the delicate porcelain insulator

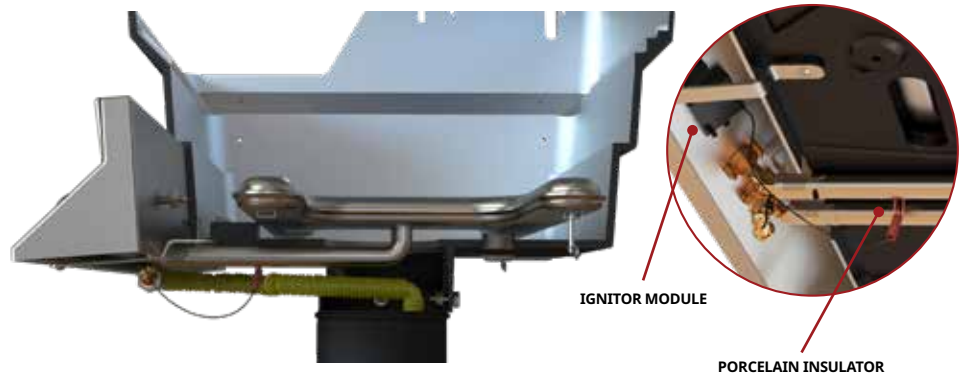

### Attach Knobs to Control Panel

Attach the two control knobs to the grill by pushing them down securely onto the valve stems.

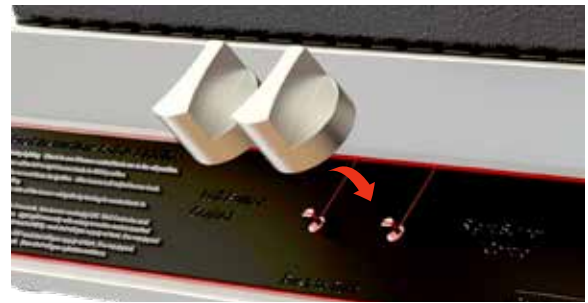

### Battery Installation

- Place the AAA battery "+" side down into the ignitor module.
- Install push button over the battery and turn clockwise to tighten in place.



### Connect the Gas Supply

Please reference the assembly manual that came with your grill mounting for directions on connecting the gas supply to your grill.

## STEP 2 INSTALLING THE SIDE SHELVES



GGDSK  
Side Shelf Kit

### PARTS INCLUDED IN BOX:



SHELF (2)



SIDE BRACKETS (4)



KEP NUTS (8)



NYLOCK NUT (4)



PHILLIPS HEAD  
BOLTS (8)

### TOOLS NEEDED:



PHILLIPS  
SCREWDRIVER



7/16"  
COMBINATION  
WRENCH

3/8"  
COMBINATION  
WRENCH

### Remove Plastic Protective Sticker

Before installing the side shelf, remove the plastic protective sticker from all sides of the shelves and shelf brackets.

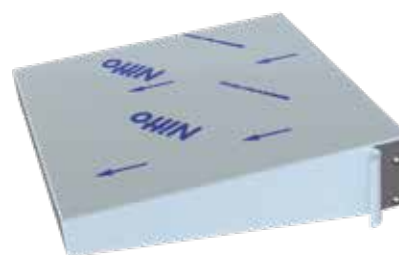

### Mount Side Shelf Brackets

- Locate the side brackets and mount the brackets to the right side of the grill.
- Attach the brackets using the supplied Phillips Head Bolts and Kep Nuts (2 Phillips Head Bolts and Kep Nuts per bracket).
- Insert the Phillips Head Bolts into the pre-drilled holes from the inside of the bottom casting and attach the Kep Nuts on the outside.
- Tighten the Kep Nuts while making sure the brackets remain parallel with the grill using a screwdriver and a 7/16" combination wrench.
- Follow the above steps to mount the brackets to the left side of the grill.

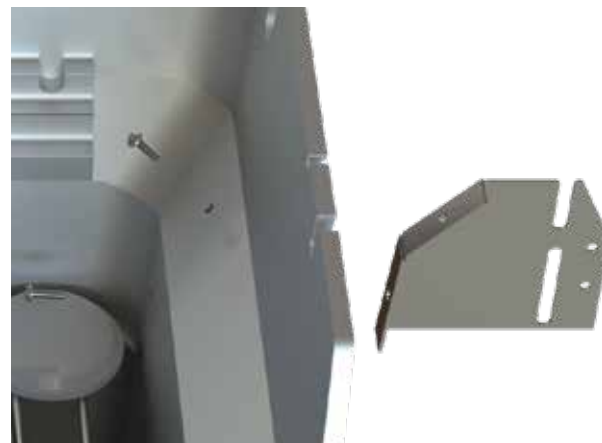

### Attach the Side Shelves

Once all brackets are in place, attach the Side Shelves.

- Place the left bottom shelf threaded screw into the left bottom bracket slot.
- Gently spread the shelf apart to insert the right bottom shelf threaded screw into the right bottom bracket slot.
- **Tighten Nylock Nuts on the bottom threaded screws using a screwdriver and a 3/8" combination wrench.** Make sure the nuts are snug but do not restrict movement of folding and unfolding of the shelf.
- Repeat steps to attached the second side shelf to the left side of the grill



⚠ **Top threaded screws on shelf do NOT use nuts.**

## STEP 3 INSTALLING THE BRIQUETTE GRATE



GG-GRATE-SS  
Briquette Grate

### PARTS INCLUDED IN BOX:



STAINLESS STEEL  
BRIQUETTE GRATE

Install the Stainless Steel Briquette Grate by placing it into the bottom grill casting. The grate should rest level on the shelf edge just above the burner.



## STEP 4 INSTALLING THE BRIQUETTES



BRIQUETTE BAG  
67 Briquettes

- Place the porcelain briquettes on top of the grate.
- Place one at a time
- Carefully place the porcelain briquettes on the grate in the pattern shown making sure to only have one layer.
- This pattern helps to distribute heat evenly and reduce flare-ups.

⚠ The bag includes 67 briquettes—you will need all 67 to fill the briquette grate properly.



## STEP 5 ATTACHING THE TOP CASTING



### PARTS NEEDED:



**OWNER'S MANUAL BAG**  
You will find the parts you need in the bag with your owner's Manual

⚠ It is recommended someone assist you with this step.



LID PIVOT PINS



HITCH PINS

### Attach the Top Casting

- Locate the top casting for your grill and place it on the back of the bottom casting, aligning the two back hinges.
- Slide the Lid Pivot Pin through both hinge holes and secure with a Hitch Pin.
- Repeat on opposite side.

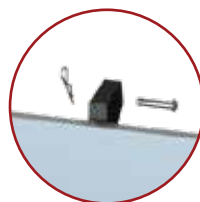

## STEP 6 ATTACHING THE FRONT HANDLE



**END CAPS/HANDLE**  
*Includes hardware*

**PARTS INCLUDED IN BOX:**



**HANDLE**



**END CAP ASSEMBLY (2)**

*Each End Cap Includes:*

- End Cap
- Graphite Gasket
- 1/4-20 x 1-1/2" Hex Bolt
- Kep Nut

**TOOLS NEEDED:**



**7/16" COMBINATION WRENCH (2)**

⚠️ **Install one end cap first, followed by the center shaft handle, then enclose it by securing the second end cap.**

### Attaching the Handle

- Attach the first end cap to the grill lid using a 1/4-20 x 1-1/2" Hex Bolt and Kep Nut making sure that the Graphite Gasket (purple element) is positioned between the end cap and the grill lid as shown.
- Tighten the end cap by using two 7/16" Combination Wrenches—one to hold the bolt head and one to tighten the Kep Nut.
- Insert the handle into both the installed end cap and second end cap
- Install the second end cap using the same method as outlined above.

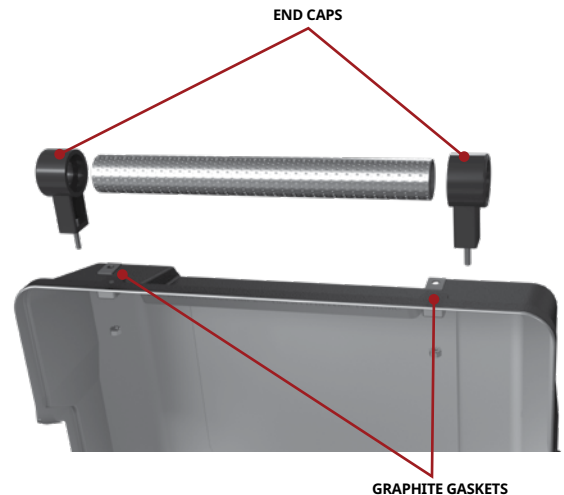

## STEP 7 INSTALLING THE TEMPERATURE GAUGE



**OWNER'S MANUAL BAG**  
*The Temperature Gauge is included in the Owner's Manual bag*

**PARTS NEEDED:**



**TEMPERATURE GAUGE ASSEMBLY**  
*Includes:*

- Temperature Gauge
- Washer (2)
- Wing Nut

### Installing the Temperature Gauge

- Insert the temperature gauge through one washer into the pre-drilled hole on the grill top casting making sure the gauge is facing outward.
- On the inside of the grill lid, install the second washer, then the Wing Nut to the temperature gauge post.
- Hand tighten the Wing Nut until temperature gauge is snug against the casting.

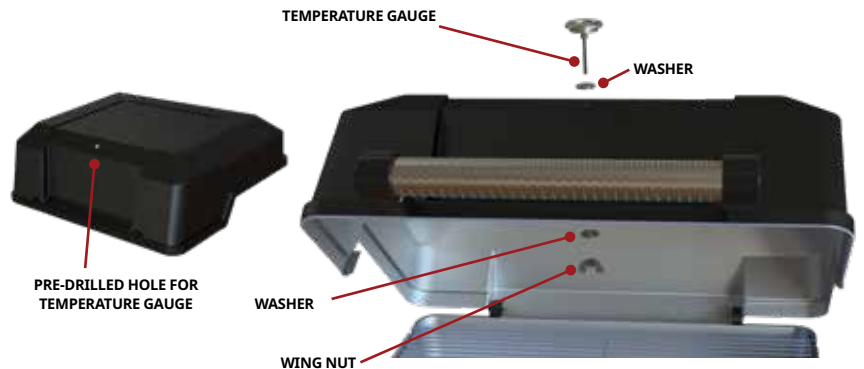



## STEP 8 ADDING THE STAINLESS STEEL OR SEARMAGIC COOKING GRIDS



### PARTS INCLUDED GG-SS-GRID BOX:

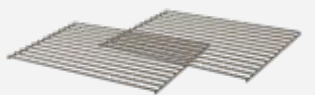

STAINLESS STEEL COOKING GRIDS (2)

GG-SS-GRID  
Stainless Steel  
Cooking Grid

OR



### PARTS INCLUDED WNK-SEAR-PK BOX:

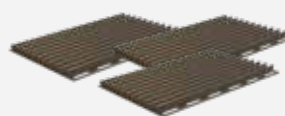

SEARMAGIC COOKING GRIDS (3)

WNK-SEAR-PK  
SearMagic Cooking Grids



GRID CLEANING TOOL  
(GGWB5)



### Installing Stainless Steel Cooking Grids

- The two stainless steel cooking grids should easily drop in side-by-side above both briquette grate and porcelain briquettes
- The top side of the Stainless Steel Grids has the rods on top of the frame.



### Installing SearMagic Cooking Grids

- The three SearMagic cooking grids should easily drop in side-by-side above both the briquette grate and the porcelain briquettes.
- The SearMagic Grids are reversible. Use the ribbed side for making sear marks on steaks and use the smooth side for more delicate items.

## STEP 9 ADDING THE WARMING RACK

### PART INCLUDED:

#### WARMING RACK GGTS

Swing-Away  
Warming Rack

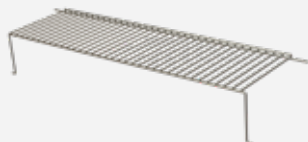

### Installing the WNK Swing-Away Warming Rack

The swing-away warming rack attaches to both the grill lid and the grill bottom casting.

- Insert the stationary rods into the top right and left mounting holes located on the grill lid.
- After inserting the stationary rods, flex the bottom swing rods to insert into the bottom right and left mounting holes located in the bottom grill casting.

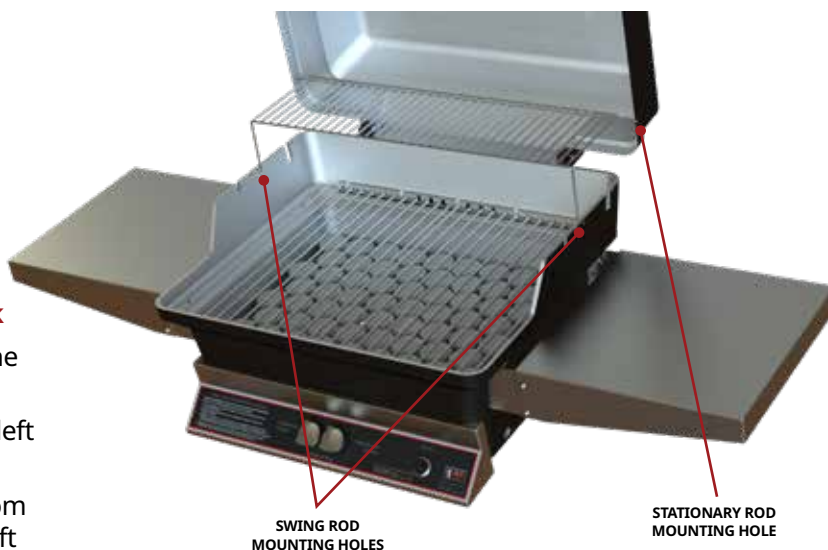

SWING ROD  
MOUNTING HOLES

STATIONARY ROD  
MOUNTING HOLE

## ATTACHING TO GAS LINE



For complete steps on connecting your grill to a gas line please refer to the instructions included in the assembly manual for your specific mounting.

### For Natural Gas & Hard-Plumbed LP Gas Installations

#### BENDING STAINLESS STEEL TUBING



Do not make sharp bends when bending your flexible stainless-steel tubing to match the feed of your grill valve and position in the top notch of the post.

### For LP GAS installations



The LP Hose and Regulator is factory installed on your control panel. Make sure the LP hose runs through the hose retention notch or clip (*depending on your specific grill mounting*). For additional information, reference your grill mounting assembly manual.

**After you have successfully assembled your grill—hook up your gas lines and check all connections.**

## LEAK TESTING

- ⚠️ LEAK TEST ALL GAS CONNECTIONS BEFORE USING YOUR GRILL.
- ⚠️ DO NOT SMOKE WHILE LEAK TESTING.
- ⚠️ DO NOT LEAK TEST WITH A MATCH OR OPEN FLAME.
- ⚠️ DO NOT USE A GRILL THAT IS LEAKING GAS.
- ⚠️ YOU SHOULD TEST FOR GAS LEAKS EVERY TIME YOU DISCONNECT AND RECONNECT A GAS FITTING.
- ⚠️ PERFORM A LEAK TEST EVEN IF YOUR GRILL WAS DEALER OR STORE ASSEMBLED.
- ⚠️ DO NOT IGNITE BURNERS WHEN LEAK TESTING.

- ▶ **For LP models, leak test with a full propane cylinder.**
- ▶ **For systems other than self-contained LP cylinders:**
  - The grill and its individual shut-off valve must be disconnected from the gas supply piping systems during any pressure testing of that system at test pressures in excess of 1/2 psi (3.5 kPa).
  - The grill must be isolated from the gas supply piping system by closing its own manual shut off valve during any pressure testing of the gas supply piping system at pressures equal to or less than 1/2 psi (3.5 kPa).

### LEAK TESTING STEPS

1. Grill burner control valves should be turned off and the gas turned on at source.
2. Apply soap solution to all gas connections. To make soap solution, mix together equal amounts of liquid detergent and water.
3. Soap bubbles will appear if there is a leak.
4. Tighten the connection using a 3/4" combination wrench and adjustable wrench to make the proper seal (one wrench is used to hold the fitting while the other is used to tighten). Recheck for soap bubbles.

### If a leak is detected...

If you have detected a leak try tightening and securing all connections. The use of two wrenches is recommended—one wrench is used to hold fitting while the other is used to tighten.

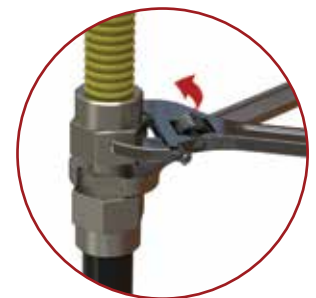

Visit your local dealer or our online store  
[www.mhponlinestore.com](http://www.mhponlinestore.com)

## Enhance Your Grill

Our premium accessories have been designed specifically for our grills with quality materials and craftsmanship



### STAINLESS STEEL SIDE BURNER

The premium commercial grade stainless steel side burner is 12,000 BTU rated, has its own electronic ignition, and is factory assembled for simple bolt-on installation. Available for both Natural and LP Gas.

**SBA3-N (Natural Gas)**  
**SBA3-P (LP Gas)**

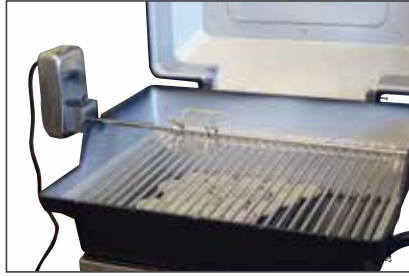

### ROTISSERIE KIT

Rotisserie Kit includes RO6 stainless steel motor, motor mounting bracket, rotisserie rod, handle, bushing, forks and 3 ft. cord. Max. 25 lb. balanced load.

**RKMHP**

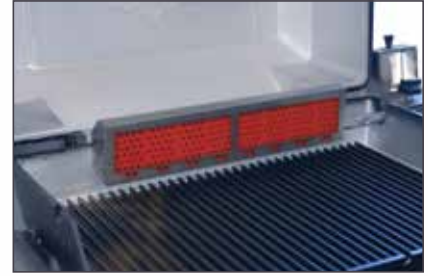

### INFRA-ROAST ROTISSERIE BURNER SYSTEM

Constructed of commercial-grade stainless steel this 12,000 BTU rated burner heats up fast and seals in juices. Easy to install or remove when not in use. Available for Natural Gas or Propane. Rotisserie Kit (RKMHP) sold separately.

**GRRRB3**



### SEARMAGIC® INFRARED SIDE GRILL

This 12,000 BTU stainless steel unit has a rust-free, anodized aluminum SearMagic® cooking grid that heats up faster and cooks food at a uniform temperature. The reversible grid provides increased cooking versatility allowing you to cook a greater variety of foods. The electronic ignition ensure easy and reliable starts while the pull-out drip tray allows for easy cleaning. The stainless steel cover provides protection and added convenience. Available for Natural Gas or Propane.

**MHPSEAR**

## Protect Your Grill

Our grill covers are constructed of a durable polyester lined vinyl, designed to protect your grills from the elements.



Mid-Length Grill Cover  
Side Shelf Up  
**GGCVPREM**



Full-Length Grill Cover  
Side Shelf Up  
**CV4PREM**



Full-Length Grill Cover  
Side Shelves Down  
**DDCVPREM**

## DON'T FORGET TO REGISTER YOUR GRILL!

It is the responsibility of the grill owner to complete and submit the warranty registration form to MHP in order for the warranty to be valid.

### What you will need to register your grill:

- A bill of sale, canceled check, or payment record is required to verify the purchase date and establish warranty period.
- Model Number
- Serial Number
- Type of Grill Purchased (Natural or LP Gas)



### How to find your grill model #/serial #

The model number tag is located on the left end cap of the control panel.

*Visit [mhpgrillpartsonline.com/warranty-registration-form/](http://mhpgrillpartsonline.com/warranty-registration-form/) to register your grill online. A mail-in registration postcard is also included with your owner's manual.*

**YOUR MODEL #: WNK**

**YOUR SERIAL #:**



***Make the most out of your grilling experience!***

From side burners and rotisseries to grill covers and more—we carry a complete line of grill upgrades, accessories and grill parts designed specifically for your MHP Grill.

**»» Visit [MHPGrills.com](http://MHPGrills.com) for more information**

### TECHNICAL SUPPORT

#### Modern Home Products

150 South Ram Road • Antioch, IL 60002  
847.395.6556 • 888.647.4745

Customerservice@mhpgrills.com • [www.mhpgrills.com](http://www.mhpgrills.com)

**⚠ California Proposition 65 Warning:** This product can expose you to chemicals including Chromium (hexavalent compounds), which are known to the State of California to cause cancer and birth defects or other reproductive harm. For more information go to: [www.P65Warnings.ca.gov](http://www.P65Warnings.ca.gov).